

# *sign*

power tools

Modular Battery Surgical Power Tool System for  
Orthopedics and Traumatology Operations

## User Manual



Please read this manual before operating your device and keep it for future reference



ACF Medical reserves the right to revise this publication and to make changes from time to time in the contents hereof without obligation to notify any person of such revision or changes, unless otherwise required by law.

**Doc. No.:** ACF.IST.55  
**Rev. No.:** 00

**Pub. Date:** 28.05.2019  
**Rev. Date:** --



ACF Medikal Ürünler Makina Sanayi ve Ticaret Limited Şirketi  
Güzelyurt Mahallesi 5754. Sokak No:3 / A Yunusemre, Manisa, TURKEY  
+90 236 236 28 20 info@acf.com.tr www.acf.com.tr

# Table of Contents

## General Informations

Introduction.....	5
Intended Use.....	5
General Warnings and Cautions.....	6
Symbol Explanations.....	7

## System Overview

A01 400- Saw / Battery / Type / 01.....	8
A01 310- Handpiece / Modular / Battery / Type / 01.....	9
A02 460 Charger Li-Ion Type / 01.....	10
A02 520 Battery Li-Ion Type / 01.....	10
A01 310 04- Battery Placement Guide for Protect Sterilization.....	10
A05 140 Sterilization Container / Type / 02.....	11
A05 160 Sterilization Container / Type / 03.....	11
Attachments for Modular Handpiece.....	12

## Battery Setup

Battery Charging.....	13
Battery Safety.....	14
Inserting Battery.....	15

## Operating Instructions

Oscillating Saw.....	17
Reamer/Drill.....	19

## Cleaning Instructions

Manual Cleaning.....	21
Automated Cleaning.....	24
Cleaning and Disinfection of Battery and Charger.....	25

## Sterilization Instructions

Preparing for Sterilization Process.....	26
Sterilization Recommendations.....	27

## After Sale Services

Troubleshooting.....	29
Repairs and Technical Service.....	30
Returning Procedure.....	30
Disposal of Waste.....	31

# GENERAL INFORMATIONS

## Introduction

This manual has been written to help describing the procedures required to keep the Modular Battery Surgical Power Tool System of ACF Medical operating properly.

This manual is published by ACF Medical. ACF Medical reserves the right that developing and changing to content of instruction manual without prior notice. But changes will publish in the next versions.

## Intended Use

Modular Battery Surgical Power Tool System is used by surgeon specialists and technicians in the field of orthopedics and traumatology for shortening time of cutting, drilling, reaming and revision of operational process of large bones (Femur and Tibia) in orthopedics surgery. Power tools can be used for the functional control by bioengineers before the operation.

This product is a high speed battery-powered surgical power tool to help forming large bones for prosthesis that is used for Arthroplasty operations.

## General Warnings and Cautions

Before using the instruments, all system component manuals should be reviewed for important warnings and instructions for use.

### Definitions

- Warning is to indicate that the safety of the patient and hospital staff could be involved.
- Caution is to point out special procedures or precautions that must be followed to avoid damaging the system / instruments.
- Note is to point out the easiest means of implementation techniques.

**WARNING 1:** All staff (doctors, assistants, etc.) who will install and use the product should be familiar with power tools and related operation.

**WARNING 2:** Be careful about that electric line has the power and current flow capacity that product needs. If you use extension cable; it must be earthed and be non-damaged.

**WARNING 3:** When you pull the trigger, if you see that the power tools do not have energy / work brokenly; you shouldn't continue the operation with this power tool, continue with other extra power tools and send the power tool to the our technical service.

**WARNING 4:** Do not touch to the blade / attachment while power tool is operating. You may get seriously injured if you do not pay attention.

**WARNING 5:** Eye protection must be worn when operating any power equipment. Dislodged burs, blades, or bone fragments can result in eye injury, blindness or contamination of the eye from patient tissue or body fluids.





















**WARNING 6:** Use care to ensure that there is no electromagnetic interference between this device and other devices in use.

**WARNING 7:** Power tools should be used in the operating room environment where appropriate conditions are provided for orthopedic operations and a spare surgical power tool should be kept ready.

**CAUTION 1:** If you drop the product from high, if it has a noticeable damage on and doesn't work properly, please do not use it. Do not open and try to fix it. Send it to our repair service.

**CAUTION 2:** During operation, do not force the power tool to reduce the speed. Please be sure that to use the power tool as its high performance.

## Symbol Explanations

	Caution		Catalogue Number
	Consult instructions for use before operating the device		Batch Code
	Caution, risk of electric shock		Serial Number
	Do not expose to stray magnetic fields		Manufacturer
	Do not lubricate		Manufacturing Date
	Non Sterile		Do not immerse the tool in liquids
	Recycling		Do not step on
	Dispose of this product according to local regulations.		Battery is full
	Left		Ready for Charging
	Right		It shows percentage of batteries.

# SYSTEM OVERVIEW

## A01 400 - Saw / Battery / Type / 01



**Center**  
The tool is off for safety



**R**  
Saw is on



**L**  
Saw is on

- 1.Saw Blade Coupling:** Insert or remove a saw blade.
- 2.Locking Knob:** Assembly and removal of a saw blade.
- 3.Trigger:** Variable speed control by contactless trigger.
- 4.Rotational Direction Switch:** Three level rotation key.
- 5.Battery Changing and Locking Mechanism:** Insert and lock A02 520 Battery Li-Ion.

- Variable speed control by contactless trigger.
- Maximum approach to the cutting area by design of sawing chuck.
- Safety by locking feature of saw holder design.
- Maximum speed, maximum power for knee and hip operations.

### Technical Details

- Speed: 15.000 cpm
- Oscillating Arc: 4°
- Operation Voltage: 14.4 V



## A01 310 - Handpiece / Modular / Battery / Type / 01

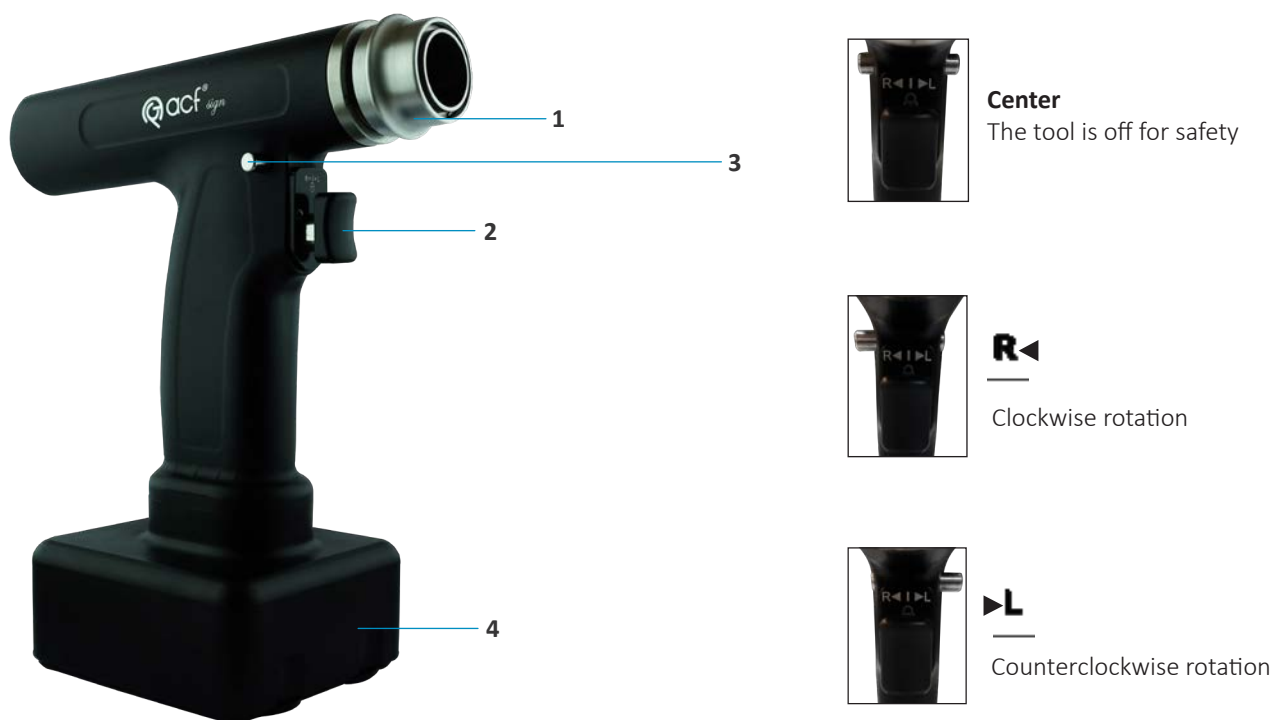

- 1. Attachment Coupling and Safety Lock:** To fix the attachments to the handpiece safely.
- 2. Trigger:** Variable speed control by contactless trigger.
- 3. Rotational Direction Switch:** Grey safety key with three gradual. The handpiece work when the grade is in the L(Left) or R(Right). The handpiece doesn't work when the grade is in the middle (safe).
- 4. Battery Changing and Locking Mechanism:** It is supplied to insert and lock the A02 520 Battery Li-Ion.

- Variable speed control by contactless trigger.
- Maximum approach to the operation area by design of modular coupling.
- Safety by locking feature of attachment holder design.
- Maximum speed, maximum power for knee and hip operations.

### Technical Details

- Drilling Speed: 0-750 rpm
- Drilling Torque: 3.9 Nm
- Reaming Speed: 0-250 rpm
- Reaming Torque: 17.8 Nm
- Operation Voltage: 14.4 V
- \*4,2 mm cannulated

## A02 460 - Charger Li-Ion Type / 01



- Battery charger has two independent charging bay

### Technical Details

- Input: 200-240 V ~ 1.7 A
- Output: 24V DC 6.5 A
- Frequency: 50-60 Hz
- Fuse Rating: 5 A 250 V

## A02 520 - Battery Li-Ion Type / 01



- Lithium Ion technology
- Long life, Long run time of the power tool
- Charges in a short time without need to discharge
- Non-sterile and **not autoclavable**

### Technical Details

- Battery Capacity: 2500 mAh
- Battery Voltage: 14.4 Volt

## A01 310 04 - Battery Placement Guide for Protect Sterilization



- Provides to protect sterilization of handpieces when inserting battery into it

## A05 140 - Sterilization Container / Type / 02



- For all handpieces and attachments
- Produced by stainless steel material
- Product placement is determined by laser marking on the trays

## A05 160 - Sterilization Container / Type / 03



- For a single handpiece and attachments
- Produced by stainless steel material
- Product placement is determined by laser marking on the trays

## Attachments for Modular Handpiece

<p><b>A01 700 Adapter for Drill (Keyed)</b></p>		<ul style="list-style-type: none"> <li>• Operating Speed 750 rpm</li> <li>• 0- 8 mm</li> </ul>
<p><b>A01 720 Adapter for Reamer (Zimmer)</b></p>		<ul style="list-style-type: none"> <li>• Operating Speed 250 rpm</li> </ul>
<p><b>A01 721 Adapter for Reamer (A.O. Synthes)</b></p>		<ul style="list-style-type: none"> <li>• Operating Speed 250 rpm</li> </ul>
<p><b>A01 723 Adapter for Reamer (Hudson &amp; Stryker)</b></p>		<ul style="list-style-type: none"> <li>• Operating Speed 250 rpm</li> </ul>
<p><b>A01 740 Adapter for Wire Driver</b></p>		<ul style="list-style-type: none"> <li>• Operating Speed 750 rpm</li> <li>• 1.6 mm to 2.5 mm</li> </ul>
<p><b>A01 750 Adapter for Pin Driver</b></p>		<ul style="list-style-type: none"> <li>• Operating Speed 750 rpm</li> <li>• 2.6 mm to 3.2 mm</li> </ul>
<p><b>A04 101 Key for Chuck Type / 01</b></p>		<ul style="list-style-type: none"> <li>• Available spin gap is 0- 8 mm.</li> </ul>

# BATTERY SETUP

## Battery Charging

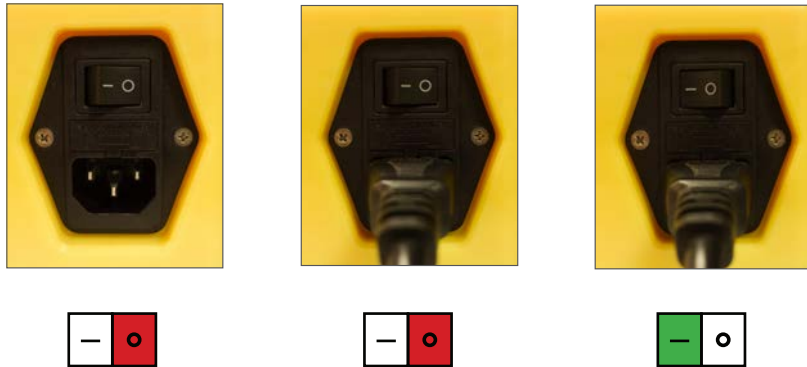

Place A02 460 Charger Li-Ion on the appropriate / flat / dry ground sufficient distance according to the operation type, insert the power cable as appropriate 220 Volts into the slot on the back of the unit.

**WARNING 8:** A02 460 Charger Li-Ion and A02 520 Battery Li-Ion are non sterile and not autoclavable.

**WARNING 9:** In countries where the mains voltage is not 220-240 V, use a voltage converter.

**CAUTION 3:** Make sure the position On-Off Switch is “O” ( Off ) before inserting plug of charger to the socket.

The battery is partially charged. To ensure full capacity, you need to completely charge the battery with the battery charger before using your power tool for the first time. The lithium-ion battery can be charged at any time without reducing its service life. Interrupting charging procedure does not damage the battery.

After turning on the charger, insert the A02 520 Battery Li-Ion to the charging bay.



“READY” LED lights up as green when the battery is placed and the percentage of the battery rates appear on the LCD screen.



When the batteries are full, “FUL” led light will begin flashing and “FUL” will appear on the screen. A02 520 Battery Li-Ion is ready to insert to the handpiece.

**CAUTION 4:** Do not leave the batteries on the charger after charging.

**CAUTION 5:** When “ERROR” led light is flashed, please get in contact with us.

NOTE: A02 520 Battery Li-Ion is rechargeable up to 800 and 1000 times depending on utilization.

**WARNING 10:** Return the device to the manufacturer if there is visible dirtiness on it.

**CAUTION 6:** Normally, one fully charged battery has sufficient capacity for an entire operation. As a precaution, a second battery should be kept ready.

Charge only with “A02 460- Charger Li-Ion”. The batteries should always be charged before use. Place the battery into the charger immediately after surgery. Keep the charger and the batteries clean and in a cool and dry place.

**Recycling:** Recycle the batteries according to national and local regulations.

### **Battery Safety**

- Do not open and dismantle.
- Do not expose to heat or fire. Avoid storage in direct sunlight.
- Do not short-circuit.
- Do not expose to mechanical shock.
- Keep away from children.
- Keep clean and dry.
- Do not store longer than 1 month in discharged state.
- Do not store longer than 1 year without recharge.
- Must be recycled or properly disposed.

## Inserting Battery

- The battery placement guide helps to insert the battery into the handpiece and prevents contamination of the handpiece by the non-sterile battery. Sterilize the guide after each use to ensure aseptic conditions.



- Position the guide securely on bottom of the handpiece.

**CAUTION 7:** If the non-sterile battery contacts the outside of the handpiece, the handpiece must be cleaned and resterilized before being used.

## Circulating Person (Non-Sterile Person)

- Insert the battery through guide into the handpiece.
- The circulating person must not touch the outside of the handpiece.



**CAUTION 8:** Inserting the batteries very quickly can cause system protection and the power tool may not work. Please wait a few seconds and reinsert the battery.

**CAUTION 9:** Be sure the A02 520 Battery Li-Ion is full before inserting to the handpiece. If the battery rate is under %40, the handpiece won't work. The batteries must be definitely charged before and after each operation.

**CAUTION 10:** Remove the battery from the handpiece and charge it after each operation. Do not leave the batteries in the handpieces. If you leave it, after a while battery life will start to be shorten and battery will malfunction.

**CAUTION 11:** Do not pull the trigger while inserting the battery. Ensure that your finger does not touch the trigger.

**CAUTION 12:** Avoid all contact with the outside of the handpiece in order not to contaminate it. Should the non-sterile battery or the circulating person's hand come into contact with the outside of the handpiece, it must be cleaned and resterilized before being used.

Remove the guide from the handpiece.

### Scrubbed Person (Sterile Person)

- Close the lid and turn the latch to "closed" situation. The power tool is ready for operation.



**CAUTION 13:** Do not contact the non-sterile battery in order to avoid contamination. Should the scrubbed person come into contact with the non-sterile battery, they must be scrubbed again. Should the handpiece be contaminated it must be cleaned and resterilized before being used.

**CAUTION 14:** Before running the tool, please wait a few seconds (max 10 seconds) for optimizing (trigger, motor and voltage control etc.) after inserting the battery to the handpiece. If you don't, you must reinsert the battery.



# OPERATING INSTRUCTIONS

## Oscillating Saw

Set the rotational direction switch to the centre position in order to avoid unintentional starting.

### Inserting Saw Blade

- Press the safety lock and provide space at the top where means around saw blade slots.
- Insert an oscillating saw blade to the power tool with a smooth movement left to right.



**WARNING 11:** While using A01 400 Saw, do not use excessive force or pry on the saw blade. Doing so may cause the blade to bend or break, causing potential injury.

**WARNING 12:** Do not use the product if it has any noticeable damage and please contact with our company.

**CAUTION 15:** Pull the trigger to run the power tools; after properly placing the blade in the cutting guide. If you pull the trigger before placing the blade; the blade will be damaged because of rubbing. Therefore it won't cut smoothly.

**WARNING 13:** If the rotational switch is not in the "center (safe)" position, do not try to insert the saw blade to the power tool. You may get seriously injured.

## **Operating the Tool**

After ensuring that the saw blade is placed properly, move the rotational direction switch on left or right side and then oscillating saw will be ready for use.

Pull the trigger to operate the power tool. If the blade is unplaced; it will be damaged because of friction.

ACF Medical recommends you to use a new saw blade for each operation to ensure that the saw blade is optimally sharpened and clean.

**CAUTION 16:** To ensure optimal performance, only use ACF saw blades. Otherwise, other saw blades may harm your tool.

**CAUTION 17:** While operating, be sure that the saw blade is at the parallel position with the cutting guide.

## **Removing Saw Blade**

Press again the safety lock until it is fully opened and remove the saw blade.

## Reamer / Drill

Set the rotational direction switch to the centre position in order to avoid unintentional starting. Pull the attachment coupling.



## Inserting Attachments



Adapter for Reamer



Adapter for Drill



Adapter for Wire / Pin Driver

Push the attachment until it engages in place. If the attachment does not engage properly then rotate the attachment gently until the drive shaft engages.

Check that the attachment coupling is closed properly by lightly pulling the attachment.

**WARNING 14:** If the rotational switch is not in the “center (safe)” position, do not try to insert the attachments to the power tool. You may get seriously injured.

**WARNING 15:** Ensure that you have chosen the proper attachment for the operation.

## **Operating the Tool**

After ensuring that the attachment is placed properly, move the rotational direction switch on left or right side and then the tool will be ready for use.

Pull the trigger to operate the power tool.

To ensure optimal performance, only use ACF attachments. Otherwise, other attachments may harm your tool.

## **Removing Attachments**

Pull the attachment coupling and pull the attachment until it gets out.

# CLEANING INSTRUCTIONS

## Manual Cleaning

1. Before cleaning, remove all instruments and attachments from the power tool. Remove the battery from the handpiece.
2. Do not use pointed objects for cleaning.
3. Rinse the device under running cold tap water.
4. Scrub debris from the handpiece using a sponge.
5. Use an enzymatic detergent to remove organic and inorganic debris according to manufacturer's directions.



6. Manipulate all moving parts of the handpiece such as to ensure all debris is removed.
7. For cannulations of the handpiece and attachments, use a syringe and an air blow gun.
8. Hold the handpiece upright to prevent water from running into the battery receptacle.
9. Visually inspect the handpiece for any remaining debris. If any debris is present, repeat the cleaning and rinsing procedure.
10. Gently shake the handpiece free of water.
11. Dry the handpiece with a clean lint-free soft cloth.



**WARNING 16:** Never immerse the handpieces and the batteries in aqueous solutions or in an ultrasonic bath. Do not use pressurized water during washing process.



**CAUTION 18:**

- DO NOT lubricate the handpieces. Lubrication may damage the internal motor mechanism.
- DO NOT immerse the handpieces and the batteries in any fluid.
- DO NOT utilize cleaning agents with chlorine or chloride as the active ingredient is corrosive to stainless steel.
- Cleaning with an ultrasonic cleaner may harm your handpieces.
- Body fluids and tissue should not be allowed to dry on instruments prior to cleaning (Maximum 30 minutes)

***Attachments are suitable for use in an ultrasonic cleaner and immerse in a fluid. Only use approved cleaning agents according to manufacturer's recommendations.***



## Automated Cleaning

Even if you have an automated cleaning system, pre-cleaning is recommended.

Modular Battery Surgical Power Tool System is suitable for use in washer. They are designed with advanced materials and sealing technologies are tested to ensure the prevention of ingress of fluids during using and cleaning.



Modular Battery Surgical Power Tool System has a water protection rating of **IPX 6**, protected against high pressure water stream from any angle.

1. Remove all instruments and attachments from the power tool. Remove the battery from the handpiece.
2. Under running tap water, remove all traces of blood and debris.



3. Load handpieces and attachments in a washer basket. Take care not to fill the basket too much and make sure that instruments have enough space to be freely cleaned. The handpieces must be in an upright position.





4. Operate according to washer manufacturer's instructions. Only use approved solutions for cleaning powered instruments according to manufacturer's recommendations.



**WARNING 16:** Never immerse the handpieces and the batteries in aqueous solutions or in an ultrasonic bath. Do not use pressurized water during washing process.

## Cleaning and Disinfection of Battery and Charger

1. **To clean** the battery and the charger, wipe them off with a clean, soft and lint-free cloth dampened with deionized water and dry prior to processing.
2. **To disinfect** the battery and charger, apply a disinfectant on a new, clean, soft and lint-free cloth and wipe the charger and the batteries off. Please pay attention **not to spray directly to the instruments**. Follow the instructions provided by the manufacturer of the disinfectant.



# STERILIZATION INSTRUCTIONS

## Preparing for Sterilization Process

Place clean and dry products (handpieces, attachments, sterilization guides) into designated locations in the sterilization container. Fasten sterilization case lid.

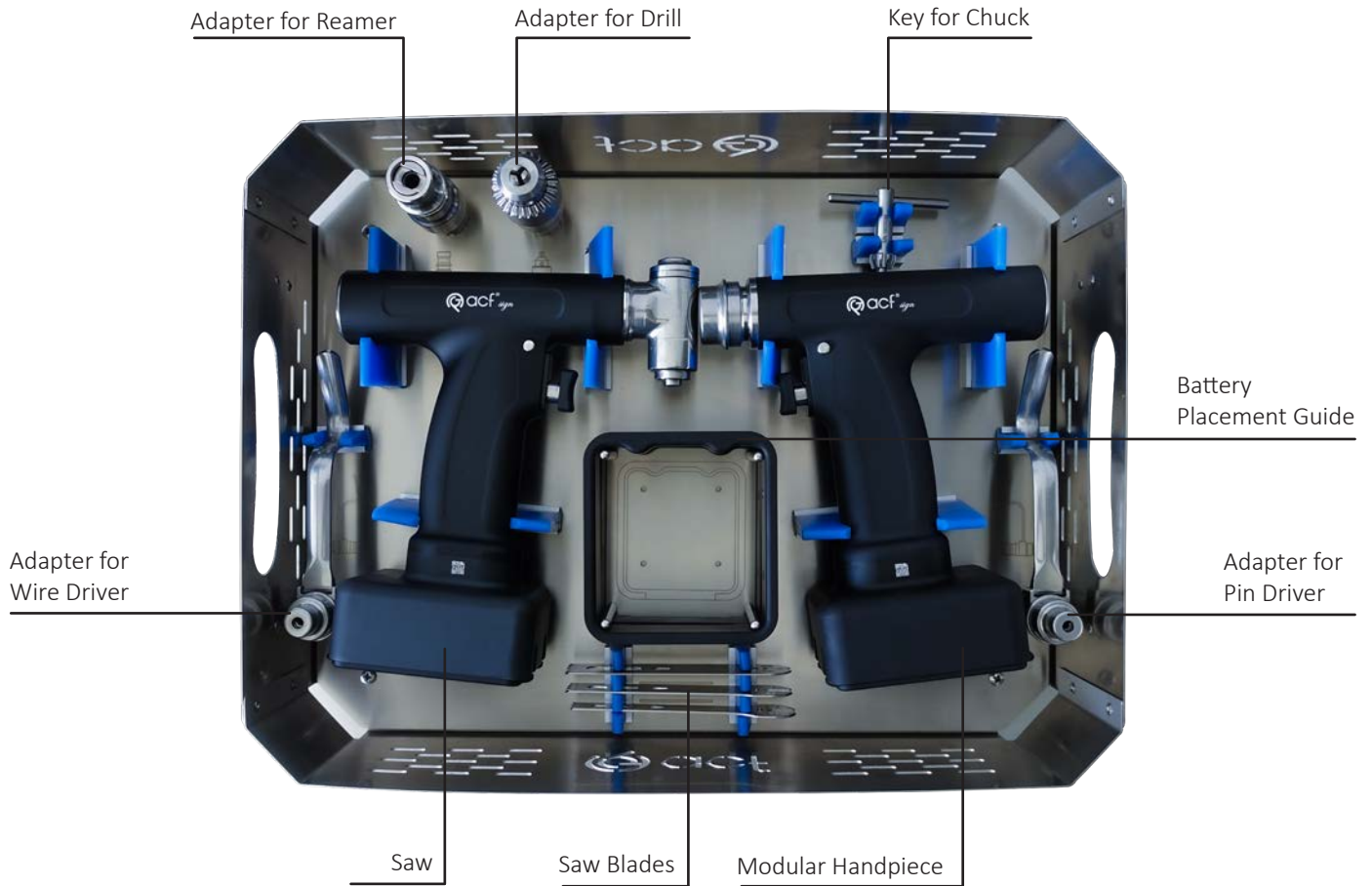

**Sterilization Container Dimensions:** Length x Width x Height  
425 x 305 x 120 mm

**WARNING 17:** Instruments are manufactured as non-sterile. They need to be sterilized before using.

**CAUTION 19:** ACF Medical recommends you to autoclave your tools and accessories in ACF sterilization container. Every instrument should be sterilized independent of each other.

## Sterilization Recommendations

1. The most effective and safe sterilization method is steam sterilization for Modular Battery Surgical Power Tool System. The instruments are capable of withstanding the recommended exposure times and temperatures of steam sterilization. Other sterilization methods are not recommended.
2. Sterilization must be carried out through a validated steam sterilization process (according to ISO 17665-1:2006).

### In case of any urgent need;

- a. Instruments can be sterilized with parameters of **134° C program for a minimum holding time of 4 minutes** as can be seen below. For normal operation procedures, validated steam sterilization process should be followed.
- b. Sterilized instruments should be used not long after sterilization. Steam autoclave should be in the most closest location to the operating room and/or sterilized instruments should be transported to the point of use under aseptic conditions.
- c. Quality controls should be recorded such as all indicator results, emergency reasons and patient information.

## Parameters for Sterilizing

<b>Sterilization Type</b>	<b>Minimum Temperature</b>	<b>Minimum Exposure</b>	<b>Dry Time</b>
Pre-Vacuum	273° F (134° C)	4 Minutes	5-30 Minutes

**WARNING 18:** Power tools and attachments need to be sterilized, before every surgical procedure, passing to a service area, returning to the supplier or manufacturer.

**CAUTION 20:** The following value must not be exceeded for sterilizing: 134° C. Higher values can damage the sterilized products.

**CAUTION 21:** Do not use the handpiece just after autoclave process till temperature of trigger mechanism to cool down and reach to room temperature. If you use it before cooling; handpiece will be damaged.

**CAUTION 22:** Do not soak device to cool them down or wrap liquid sterilant around them. Do not accelerate the cooling process as it will damage the electronic components of the power tool and could result in harm to the user and patient.

**WARNING 19:** The principles of aseptic technic should be followed before/while using the tool.

## Storage

Packaged and sterilized products should be stored in a dry, clean environment, protected from direct sunlight, pests, and extremes of temperature and humidity. Use products in the order in which they are received (first-in, first-out principle), taking note of any expiration date on the label.

**CAUTION 23:** In order to prevent any missing product in the set to be sterilized; be ensure that the set content is checked before sterilization process.

## AFTER SALE SERVICES

### Troubleshooting

Problem	Cause	Steps
<i>Handpiece is not working when pulling the trigger.</i>	Rotation switch is on the "center" position	Switch the Left/Right safety key on the middle of handpiece body L or R position.
	Handpiece is taken out from autoclave and it is still warm	Wait for till handpiece is cooled down sufficiently (room temperature)
	The battery discharged or working under %40 battery rate without recharging.	Please use fully charged batteries (%100) in every operation. The batteries must recharge before and after every operation.
	Battery is not inserted to the handpiece sufficiently.	Make sure the battery is inserted sufficiently and close the safety lock. Make sure you hear "Click" voice.
	Not to wait a few seconds after inserting battery.	Please wait a few seconds after inserting battery.
<i>Battery is not charging</i>	Battery is not inserted to the charger properly.	Make sure the the battery is inserted to the charger properly.
	Power cable is unplugged to the charger or On / Off Switch is not on the "I" position.	Make sure the power cable is plugged to the charger and On / Off Switch is on the "I" position.
<i>Bone and tool heat up during surgery.</i>	Cutting edges of the tool are blunt.	Replace the tool.

## **Repairs and Technical Service**

The power tool should be sent to ACF Medical for repair if it is faulty or malfunctions.

Contaminated products have to be cleaned before being sent to ACF Medical for repair or technical service.

Faulty devices must not be used. If it is no longer possible or feasible to repair the power tool it should be disposed of the following section “Disposal of Waste”.

Please refer to the regulations for transporting Li-Ion batteries when returning them to the ACF Medical.

ACF Medical excludes liability for damage resulting from unauthorized servicing of the tool.

## **Returning Procedure**

Firstly contact with ACF Technical Service when you see a fault on the product.

Make clear with the technical team that which piece of the product is out of order.

Return the fault detected product to the factory in accordance with the directions as determined by the ACF Team.

The products, which are not shipped according to ACF instructions, will be returned to the customer.

Any repair costs may arise out of warranty, you will be informed by ACF Medical to get your approval.

Please return the products in accordance with the following procedures;

- Sterile products in accordance with instruction for use of products.
- Make the product is packaged to not be damage during the shipment.
- Please ship Lithium-Ion battery in accordance with the conditions of user manual, when delivering.
- Please call the ACF customer support team before shipping if Lithium-Ion battery is damaged.
- Please add related product’s LOT and S/N (serial) number and brief description of product’s breakdowns on the delivery note to send the product.

## Disposal of Waste

In most cases, faulty power tools can be repaired.

Please send devices that are no longer used to ACF Medical. This ensures that they are disposed of in accordance with the national application of the respective directive. The device must not be disposed of with household waste.

Faulty batteries must not be reused and should be disposed of in an environmentally friendly manner and in accordance with national regulations.

The European Battery Directive 2006/66/EC applies to this device. This device contains Lithium-Ion batteries that should be disposed of in accordance with environment protection requirements. Please observe national regulations.



Li-Ion

The European Directive 2012/19/EC on waste electrical and electronic equipment (WEEE) applies to this device. This device contains materials that should be disposed of in accordance with environment protection requirements. Please observe national regulations.



