

Dayanıklı.
Güvenilir.
İşinizi kolaylaştıran.

Cerrahi Testere Bıçak

Ürün Kataloğu

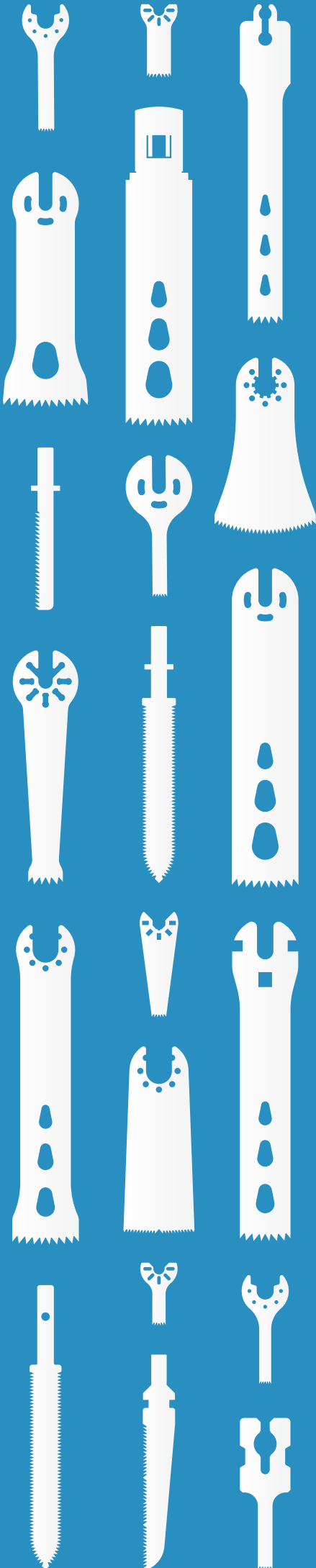

İçindekiler

Yararlı İçerikler.....	3
Cerrahi Testere Bıçakların Hikayesi - Acef Animasyon Serisi.....	4
Tasarım & Faydalar.....	5
Testere Bıçak Seçimi.....	6
Uyarı & İkazlar / Telif Hakkı Bilgileri.....	7
ACF® ile Uyumlu Testere Bıçaklar (Marka Kodu 360).....	8
Microaire® ile Uyumlu Testere Bıçaklar (Marka Kodu 100).....	19
Stryker® ile Uyumlu Testere Bıçaklar (Marka Kodu 120).....	32
Conmed Linvatec® ile Uyumlu Testere Bıçaklar (Marka Kodu 140 / 100).....	52
De Soutter® ile Uyumlu Testere Bıçaklar (Marka Kodu 200).....	68
Smith & Nephew Dyonics® ile Uyumlu Testere Bıçaklar (Marka Kodu 210).....	83
Depuy Synthes® ile Uyumlu Testere Bıçaklar (Marka Kodu 220).....	86
Zimmer® ile Uyumlu Testere Bıçaklar (Marka Kodu 220 / 223).....	100
Brasseler® / TAVA® ile Uyumlu Testere Bıçaklar (Marka Kodu 260).....	111
B Braun Aesculap® ile Uyumlu Testere Bıçaklar (Marka Kodu 320 / 330).....	120

Yararlı İçerikler

Cerrahi testere bıçakları, kısa süreli kullanılan ve vücutta kalmayan yardımcı ekipmanlar olmalarına rağmen; neden eklem protezi kadar önemlidir?

Detaylı bilgileri, kanıtlarla birlikte web sitemizdeki Yararlı İçerikler sayfamızda bulabilir veya aşağıdaki QR kodlarından cep telefonunuzla direkt olarak ulaşabilirsiniz.



ACF Website / Yararlı İçerikler

Ortopedi Operasyonlarındaki Kemik Kesme ve Delme İşlemlerinde Isının Önemi

ACF Website / Yararlı İçerikler
Diz Artroplastisinde Testere Kesim Doğruluğu

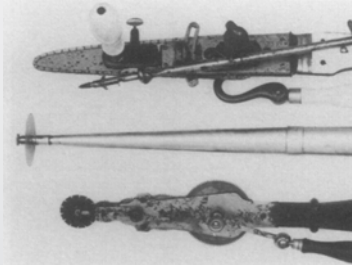

ACF Website / Yararlı İçerikler

Cerrahi Bıçakların Kökeni ve Kemik Kesme İşlemlerindeki Bıçak Tipleri

ACF Website / Yararlı İçerikler
Testere Bıçaklar Neden Tek Kullanımlıdır?

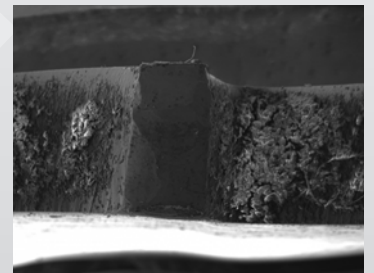

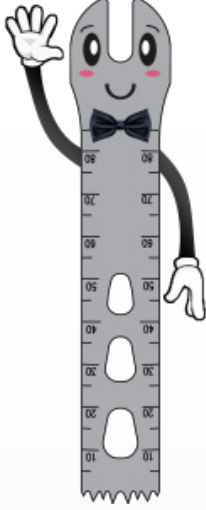

Herkesle merhaba. Ben acef!

*ACEF ile cerrahi testere bıçaklarının hikayesine tanık olun.
Animasyon serimize aşağıdaki QR kodlarından ulaşabilirsiniz.*



Bölüm 1
İşte Cerrahi Testerelerin Hikayesi Başlıyor
Lütfen izlemek için QR kodunu tarayın.



Bölüm 2
Cerrahi Testere Bıçaklarının Hikayesi
Lütfen izlemek için QR kodunu tarayın.



Bölüm 3
Geçmişten Günümüze Cerrahi Testereler
Lütfen izlemek için QR kodunu tarayın.



Bölüm 4
Acef Kullanıcılara Sesleniyor
Lütfen izlemek için QR kodunu tarayın.



Bölüm 5
Acef Kullanımından Etkilenenlere Sesleniyor
Lütfen izlemek için QR kodunu tarayın.

Tasarım & Faydalar

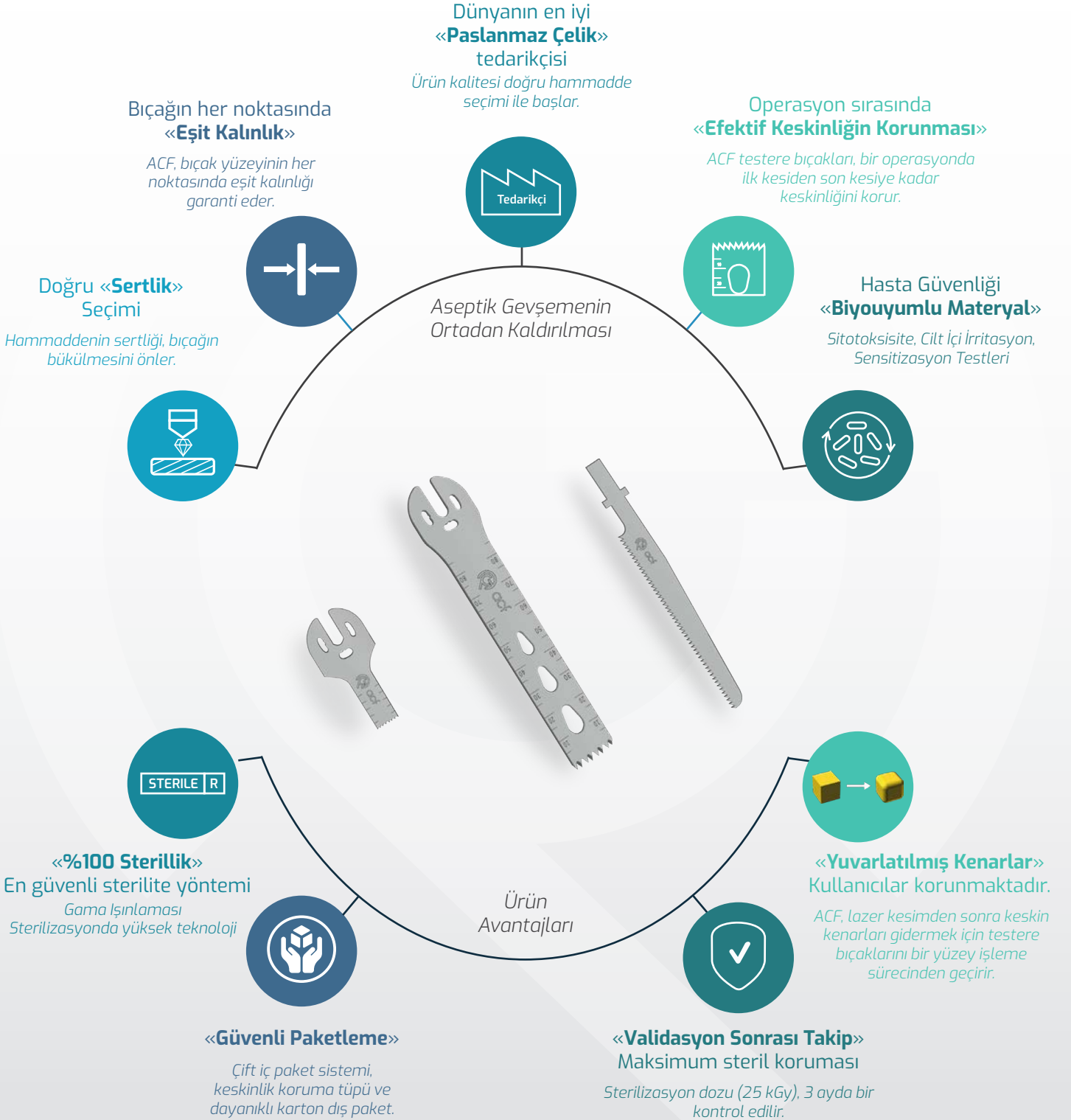



Testere Bıçak Seçimi

Konuşan Referans Kodu

En kolay kod sistemi. Anlaşılır ve sipariş vermeye hazır.

REF 360 190 090 120



Marka Kodu : Bu kod, cerrahi bıçağın uyumlu olduđu cerrahi motor markasını gösterir.

Uç Geniřliđi : Geniřlik, bıçağın uç kısmındaki en diř diřlerin arasında kalan mesafedir.

Kesi Derinliđi : Derinlik, kesi yapılırken kullanılabilen maksimum uzunluktur.

Kalınlık : Bıçağın ön ve arka yüzü arasındaki paslanmaz çelik kalınlıđıdır.

Uyarı & İkazlar

- Cerrahi testere bıçakların beraberindeki kullanım kılavuzunu dikkatlice okuyunuz.
- Tek kullanımlıdır. Testere bıçakların birden fazla kez kullanımı, kırılmaya ve kesici motorun bozulmasına neden olabilir.
- Testere bıçaklar, ikinci kez kullanım için bileylenmemelidir. Bu, kesici motorun performansını olumsuz yönde etkileyebilir.
- Kesici motor çalıştırılmadan önce testere bıçağın yerine emniyetli ve sıkı bir şekilde oturduğundan emin olunuz.
- Üreticinin cerrahi motor için önerdiği çalışma koşulları aşılmamalıdır.
- Periyodik olarak testere bıçağın ısısını takip ediniz. Testere bıçakları kullanırken aynı zamanda irigasyon kullanılması, termal nekroz olasılığını azaltmaya yardımcı olacaktır.
- Testere bıçakların kesi kılavuzu içerisinde rahat hareket etmesi sağlanmalıdır.
- Salınım yönünün aksine bir kuvvet kullanılması testere bıçağının kırılmasına neden olabilir.
- Testere bıçak üzerine markalanan ölçüler sadece bilgi amaçlıdır.
- Kazaları önlemek için kesici aletlerle çalışılırken dikkatli olunmalıdır.

Telif Hakkı Bilgileri

- Microaire®, MicroAire Surgical Instruments LLC'nin tescilli ticari markasıdır.
- Stryker®, Stryker Corporation'ın tescilli ticari markasıdır.
- Conmed Linvatec®, ConMed Corporation'ın tescilli ticari markasıdır.
- De Soutter®, De Soutter Medical Ltd'nin tescilli ticari markasıdır.
- Smith & Nephew Dyonics®, Smith & Nephew, Inc.'in tescilli ticari markasıdır.
- Depuy Synthes®, DePuy Synthes, Inc.'in tescilli ticari markasıdır.
- Zimmer®, Zimmer Inc.'nin tescilli ticari markasıdır.
- Brasseler®, Brasseler U.S.A., Inc.'nin tescilli ticari markasıdır.
- TAVA®, TAVA Surgical'ın tescilli ticari markasıdır.
- B Braun Aesculap®, B. Braun Melsungen AG ve Aesculap AG'nin tescilli ticari markasıdır.

ACF Medikal, yukarıda listelenen ticari marka sahipleriyle ilişkili değildir.



ACF[®]
ile Uyumlu
Testere Bıçaklar



Marka Kodu **360**

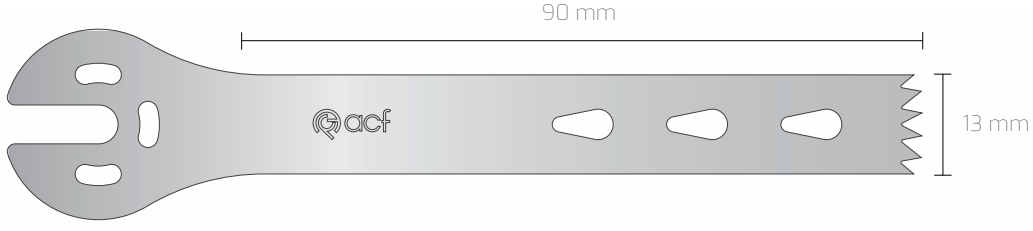

● Non Steril
● Steril R

Ref	360 130 090 089	360 130 090 090	360 130 090 100	360 130 090 119	360 130 090 120
Kalınlık	0,89 mm	0,90 mm	1,00 mm	1,19 mm	1,20 mm

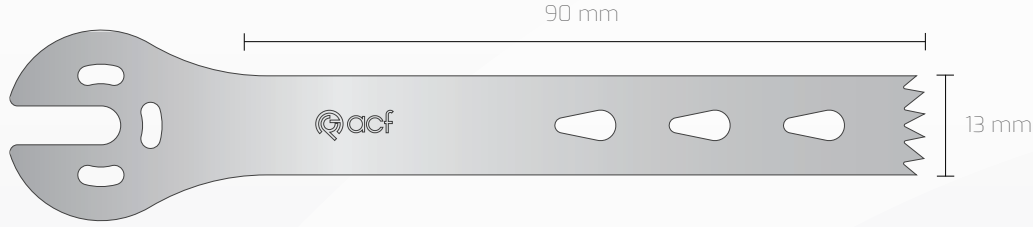

● Non Steril
● Steril R

Ref	360 130 090 127	360 130 090 130	360 130 090 137	360 130 090 140	360 130 090 147
Kalınlık	1,27 mm	1,30 mm	1,37 mm	1,40 mm	1,47 mm

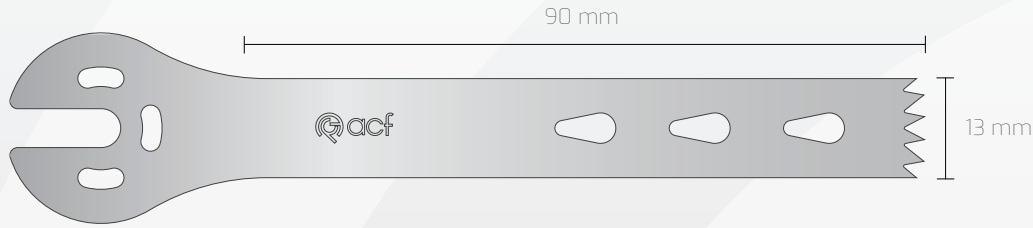

● Non Steril
● Steril R

Ref	360 130 090 150
Kalınlık	1,50 mm

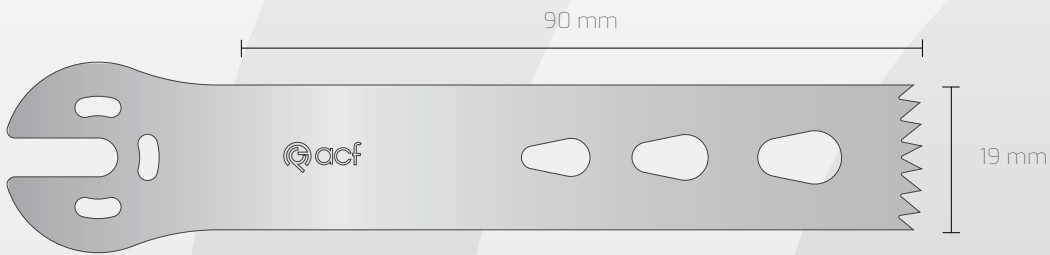

● Non Steril
● Steril R

Ref	360 190 090 089	360 190 090 090	360 190 090 100	360 190 090 119	360 190 090 120
Kalınlık	0,89 mm	0,90 mm	1,00 mm	1,19 mm	1,20 mm

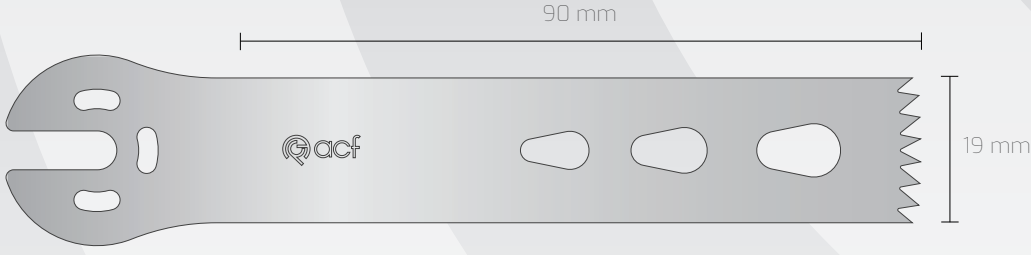

● Non Steril
● Steril R

Ref	360 190 090 127	360 190 090 130	360 190 090 137	360 190 090 140	360 190 090 147
Kalınlık	1,27 mm	1,30 mm	1,37 mm	1,40 mm	1,47 mm

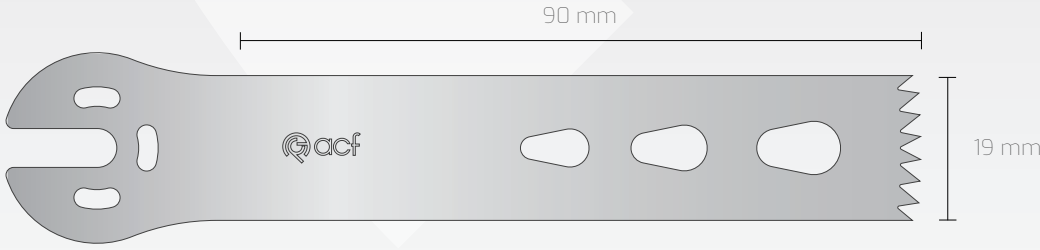

● Non Steril
● Steril R

Ref	360 190 090 150
Kalınlık	1,50 mm

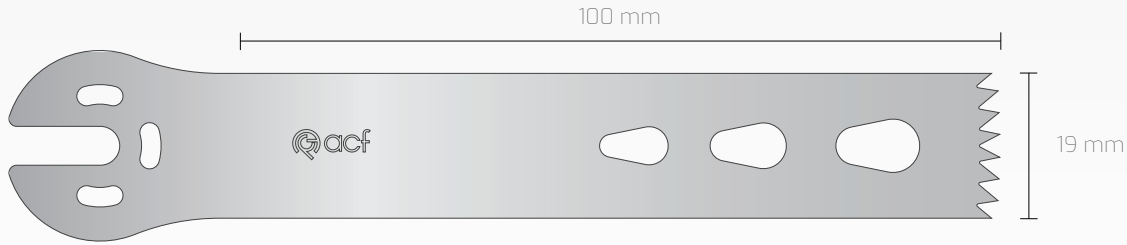

● Non Steril
● Steril R

Ref	360 190 100 089	360 190 100 090	360 190 100 100	360 190 100 119	360 190 100 120
Kalınlık	0,89 mm	0,90 mm	1,00 mm	1,19 mm	1,20 mm

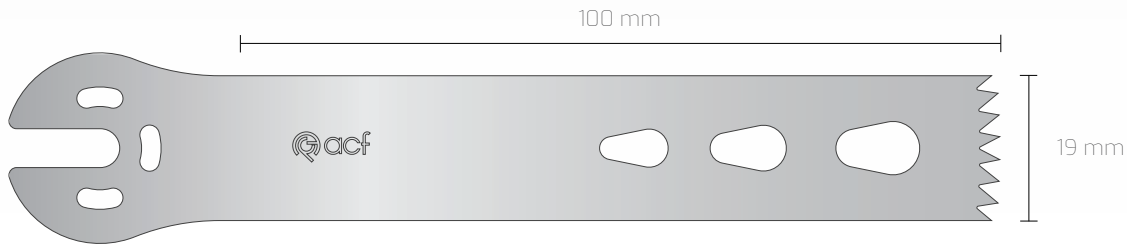

● Non Steril
● Steril R

Ref	360 190 100 127	360 190 100 130	360 190 100 137	360 190 100 140	360 190 100 147
Kalınlık	1,27 mm	1,30 mm	1,37 mm	1,40 mm	1,47 mm

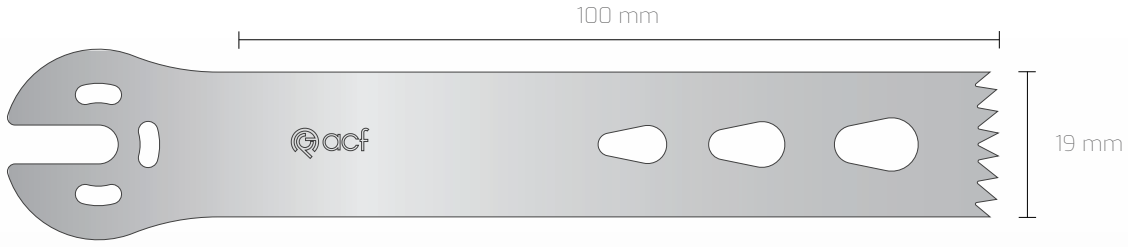

● Non Steril
 ● Steril R

Ref 360 190 100 150
Kalınlık 1,50 mm

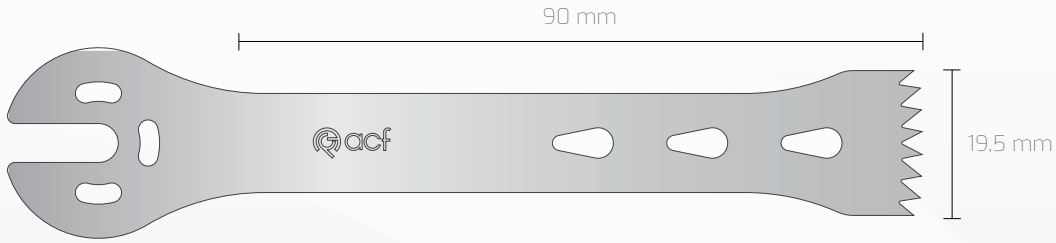

● Non Steril
 ● Steril R

Ref	360 195 090 089	360 195 090 090	360 195 090 100	360 195 090 119	360 195 090 120
Kalınlık	0,89 mm	0,90 mm	1,00 mm	1,19 mm	1,20 mm

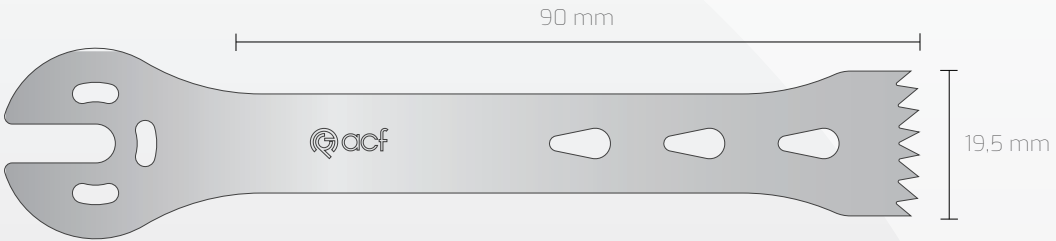

● Non Steril
 ● Steril R

Ref	360 195 090 127	360 195 090 130	360 195 090 137	360 195 090 140	360 195 090 147
Kalınlık	1,27 mm	1,30 mm	1,37 mm	1,40 mm	1,47 mm

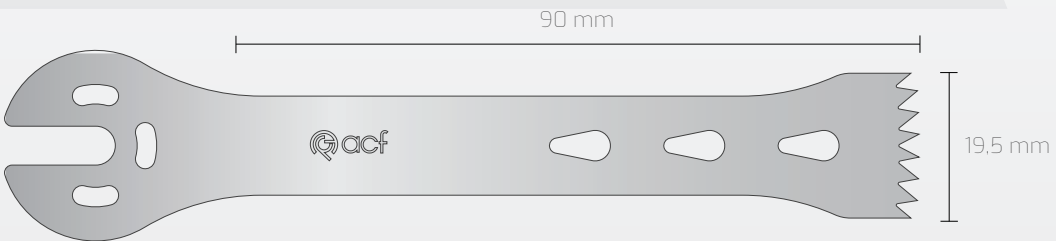

● Non Steril
 ● Steril R

Ref 360 195 090 150
Kalınlık 1,50 mm

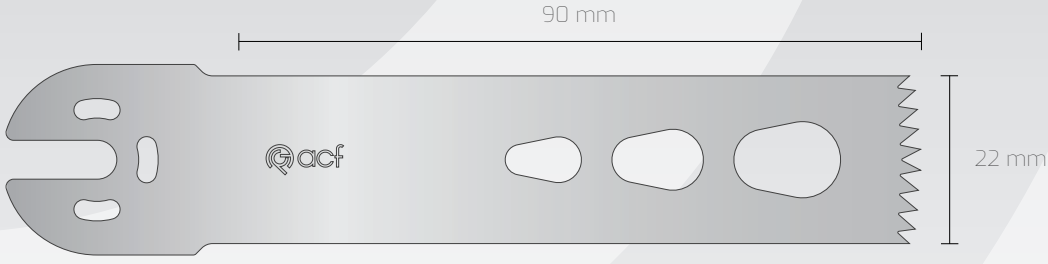

● Non Steril
● Steril R

Ref	360 220 090 089	360 220 090 090	360 220 090 100	360 220 090 119	360 220 090 120
Kalınlık	0,89 mm	0,90 mm	1,00 mm	1,19 mm	1,20 mm

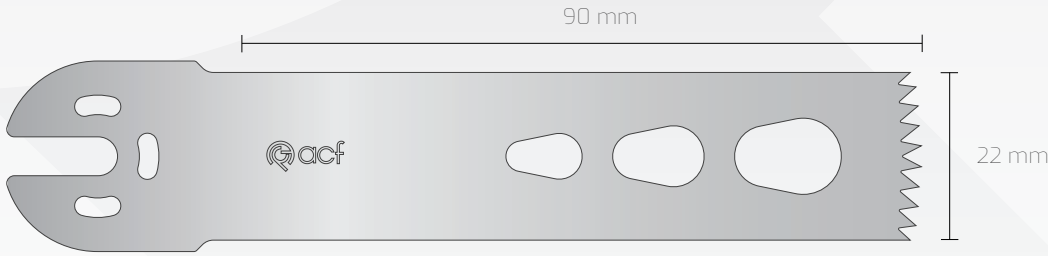

● Non Steril
● Steril R

Ref	360 220 090 127	360 220 090 130	360 220 090 137	360 220 090 140	360 220 090 147
Kalınlık	1,27 mm	1,30 mm	1,37 mm	1,40 mm	1,47 mm

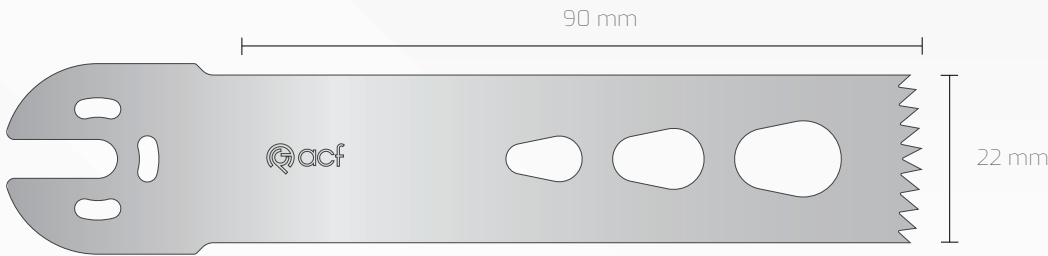

● Non Steril
● Steril R

Ref	360 220 090 150
Kalınlık	1,50 mm

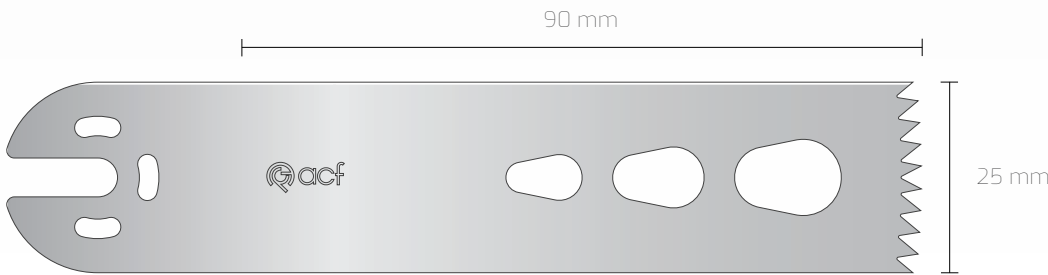

● Non Steril
● Steril R

Ref	360 250 090 089	360 250 090 090	360 250 090 100	360 250 090 119	360 250 090 120
Kalınlık	0,89 mm	0,90 mm	1,00 mm	1,19 mm	1,20 mm

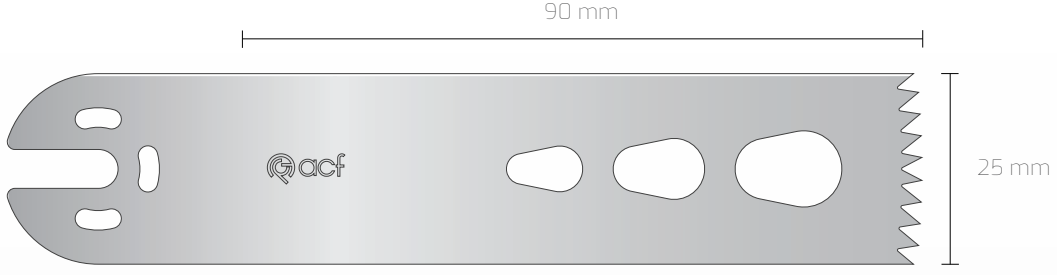

● Non Steril
 ● Steril R

Ref	360 250 090 127	360 250 090 130	360 250 090 137	360 250 090 140	360 250 090 147
Kalınlık	1,27 mm	1,30 mm	1,37 mm	1,40 mm	1,47 mm

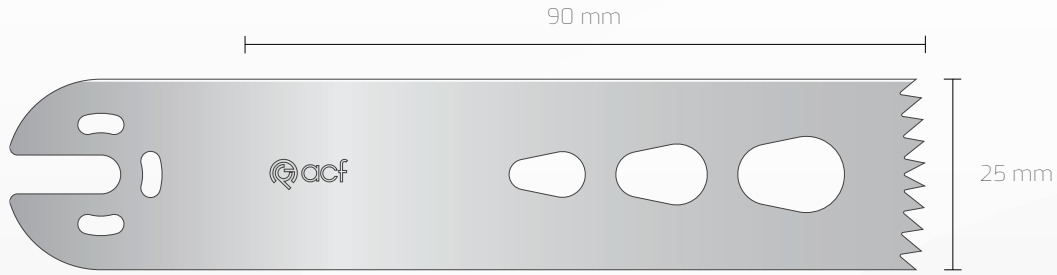

● Non Steril
 ● Steril R

Ref	360 250 090 150
Kalınlık	1,50 mm

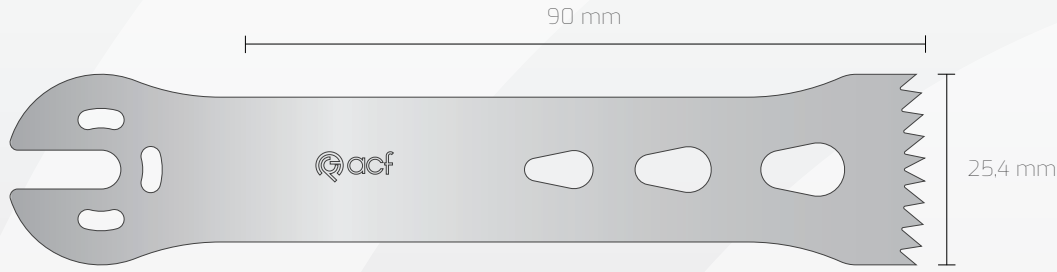

● Non Steril
 ● Steril R

Ref	360 254 090 089	360 254 090 090	360 254 090 100	360 254 090 119	360 254 090 120
Kalınlık	0,89 mm	0,90 mm	1,00 mm	1,19 mm	1,20 mm

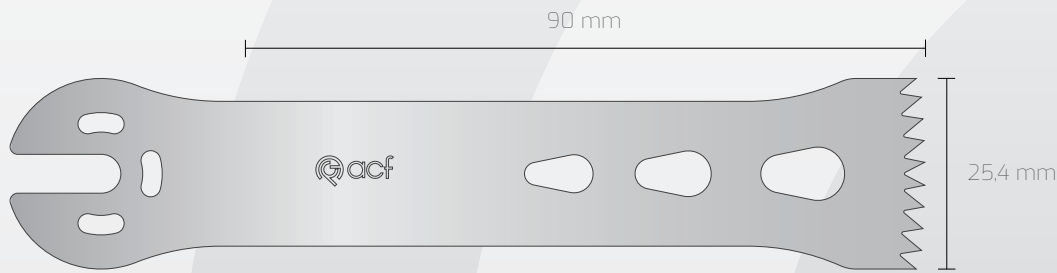

● Non Steril
 ● Steril R

Ref	360 254 090 127	360 254 090 130	360 254 090 137	360 254 090 140	360 254 090 147
Kalınlık	1,27 mm	1,30 mm	1,37 mm	1,40 mm	1,47 mm

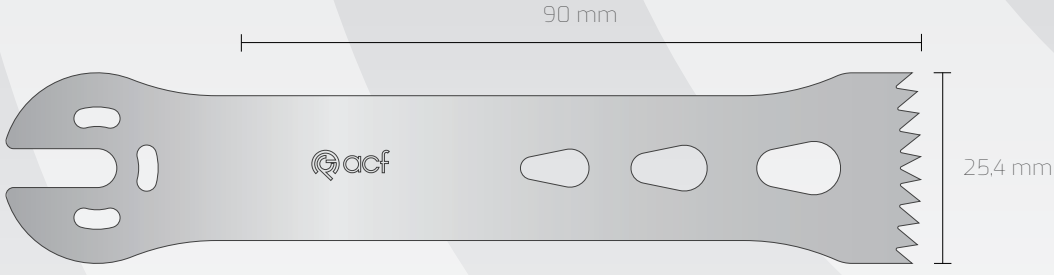

● Non Steril

● Steril R

Ref 360 254 090 150

Kalınlık 1,50 mm

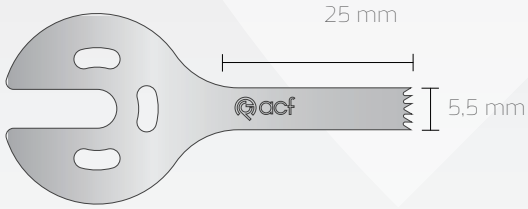

● Non Steril

● Steril R

Ref 360 055 025 060

Kalınlık 0,60 mm

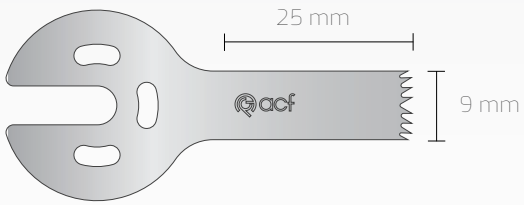

● Non Steril

● Steril R

Ref 360 090 025 060

Kalınlık 0,60 mm

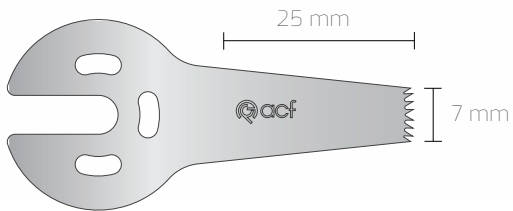

● Non Steril

● Steril R

Ref 360 070 025 060

Kalınlık 0,60 mm

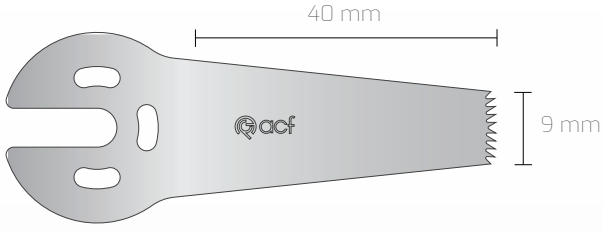
●
Non Steril●
Steril R**Ref** 360 090 040 060

Kalınlık 0,60 mm

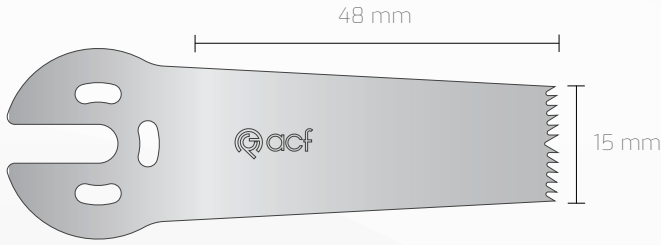
●
Non Steril●
Steril R**Ref** 360 150 048 060

Kalınlık 0,60 mm

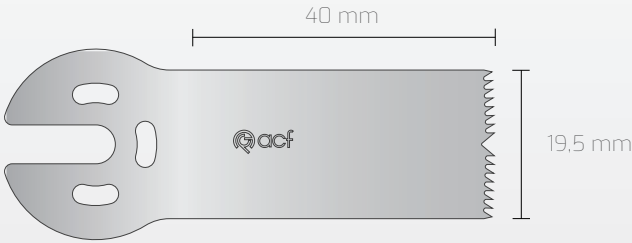
●
Non Steril●
Steril R**Ref** 360 195 040 060

Kalınlık 0,60 mm

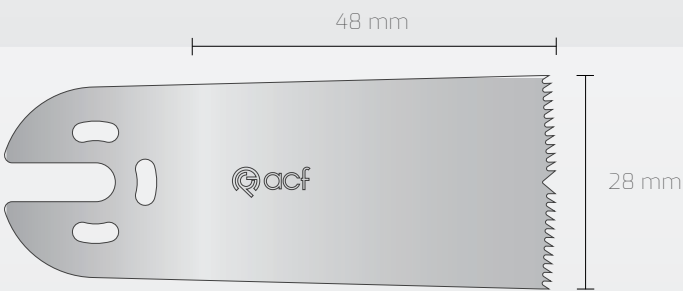
●
Non Steril●
Steril R**Ref** 360 280 048 060

Kalınlık 0,60 mm

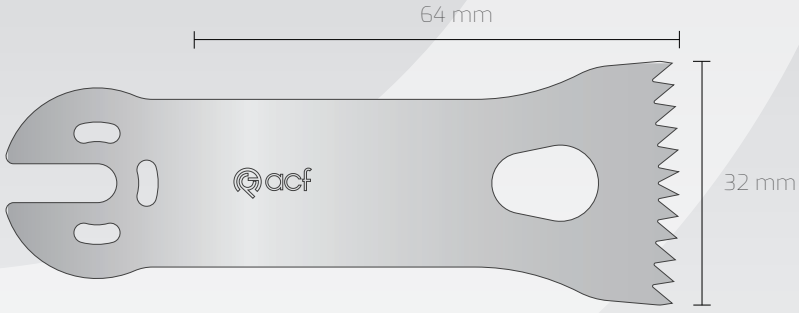

● Non Steril
● Steril R

Ref 360 320 064 090

Kalınlık 0,90 mm

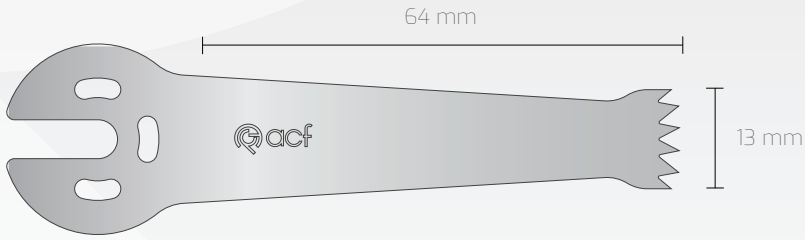

● Non Steril
● Steril R

Ref 360 130 064 090

Kalınlık 0,90 mm

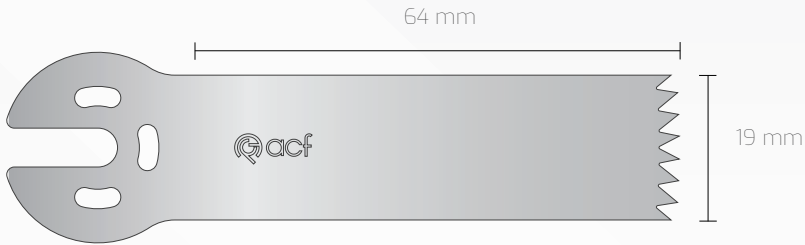

● Non Steril
● Steril R

Ref 360 190 064 090

Kalınlık 0,90 mm

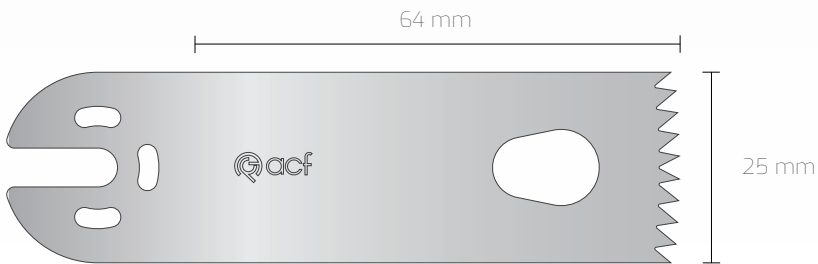

● Non Steril
● Steril R

Ref 360 250 064 090

Kalınlık 0,90 mm

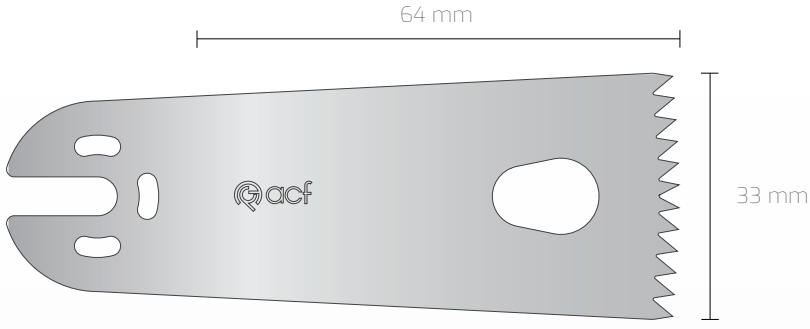

● Non Steril
● Steril R

Ref **360 330 064 090**
Kalınlık 0,90 mm

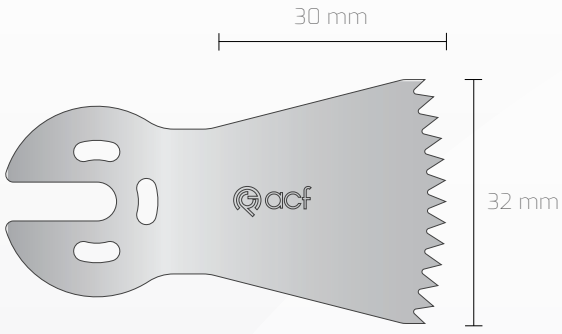

● Non Steril
● Steril R

Ref **360 320 030 090**
Kalınlık 0,90 mm

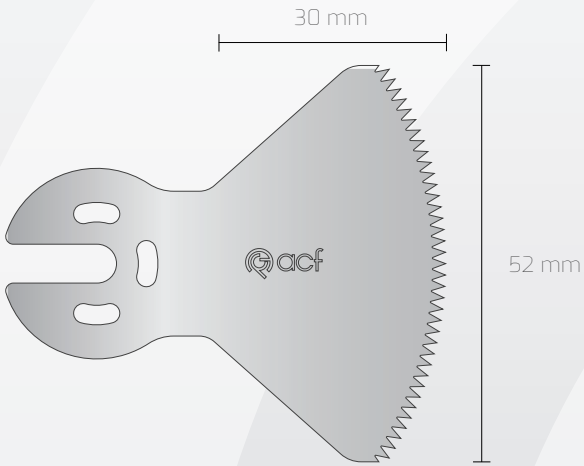

● Non Steril
● Steril R

Ref **360 520 030 060** **360 520 030 090**
Kalınlık 0,60 mm 0,90 mm

ACF Medikal®

Uyumlu Modeller;

Sign Modüler Sistemler,

A00 120 Kablolu Sistem,

A00 140 Bataryalı Sistem

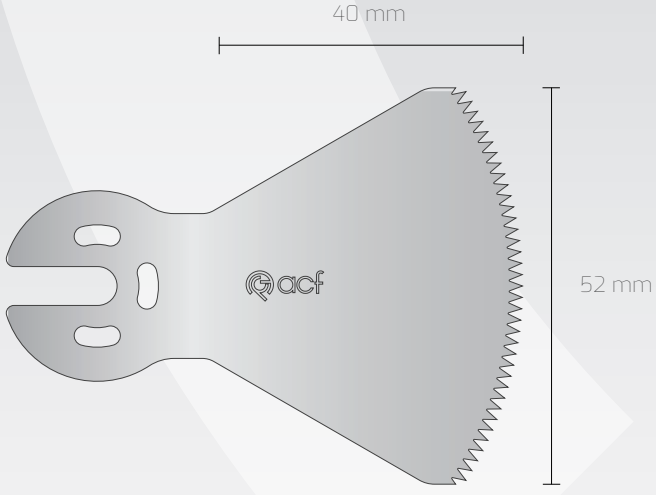

● Non Steril

● Steril R

Ref	360 520 040 060	360 520 040 090
Kalınlık	0,60 mm	0,90 mm

ACF MEDİKAL®



MICROAIRE[®]
ile Uyumlu
Testere Bıçaklar



Marka Kodu **100**

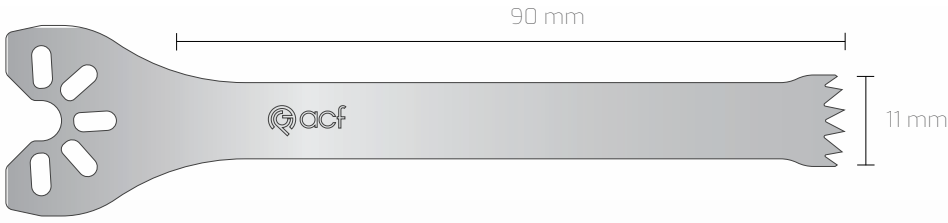

● Non Steril
● Steril R

Ref	100 110 090 089	100 110 090 119	100 110 090 127
Kalınlık	0,89 mm	1,19 mm	1,27 mm

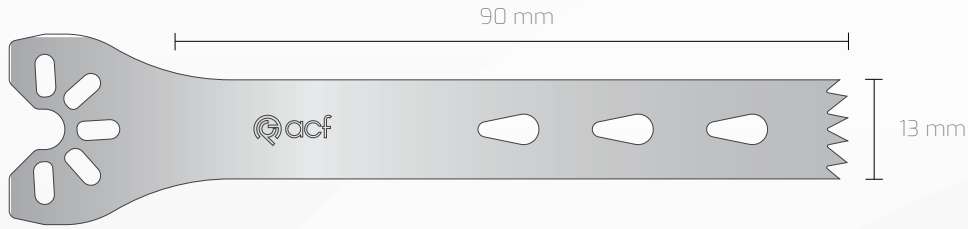

● Non Steril
● Steril R

Ref	100 130 090 089	100 130 090 090	100 130 090 100	100 130 090 119	100 130 090 120
Kalınlık	0,89 mm	0,90 mm	1,00 mm	1,19 mm	1,20 mm

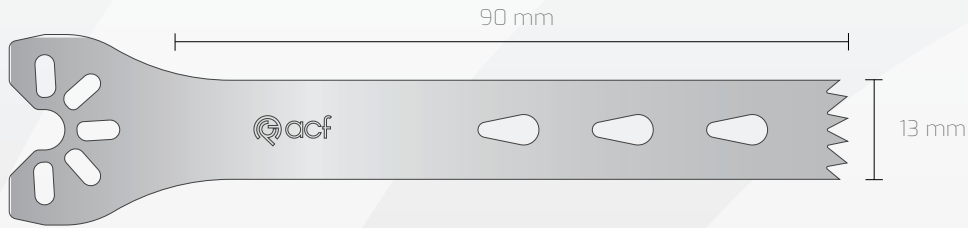

● Non Steril
● Steril R

Ref	100 130 090 127	100 130 090 130	100 130 090 137	100 130 090 140	100 130 090 147
Kalınlık	1,27 mm	1,30 mm	1,37 mm	1,40 mm	1,47 mm



● Non Steril
● Steril R

Ref	100 130 090 150
Kalınlık	1,50 mm

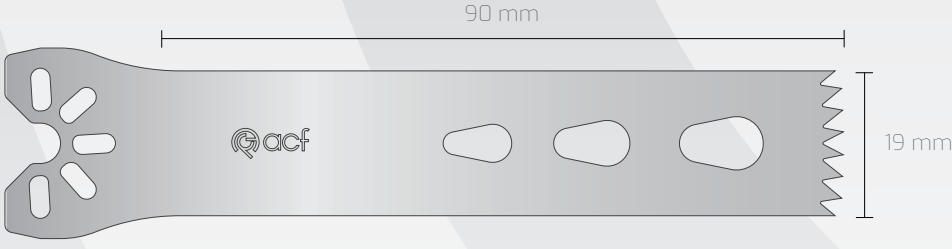

Ref	100 190 090 089	100 190 090 090	100 190 090 100	100 190 090 119	100 190 090 120
Kalınlık	0,89 mm	0,90 mm	1,00 mm	1,19 mm	1,20 mm

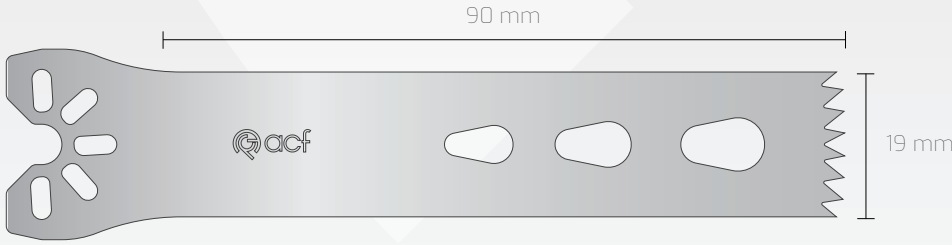

Ref	100 190 090 127	100 190 090 130	100 190 090 137	100 190 090 140	100 190 090 147
Kalınlık	1,27 mm	1,30 mm	1,37 mm	1,40 mm	1,47 mm

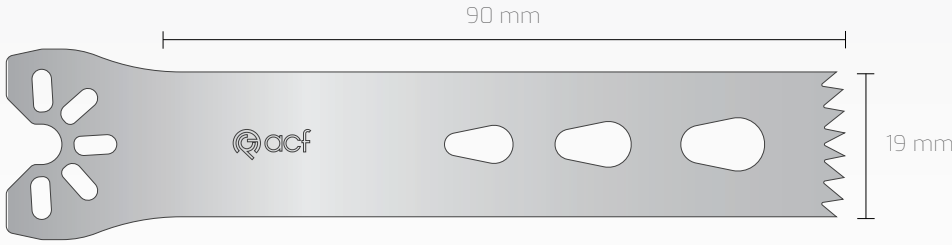

Ref	100 190 090 150
Kalınlık	1,50 mm

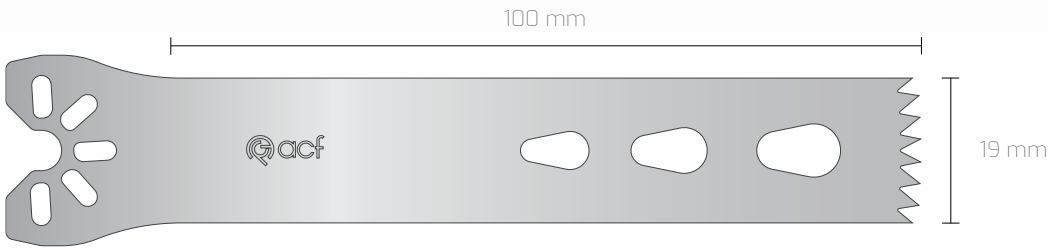

Ref	100 190 100 089	100 190 100 090	100 190 100 100	100 190 100 119	100 190 100 120
Kalınlık	0,89 mm	0,90 mm	1,00 mm	1,19 mm	1,20 mm

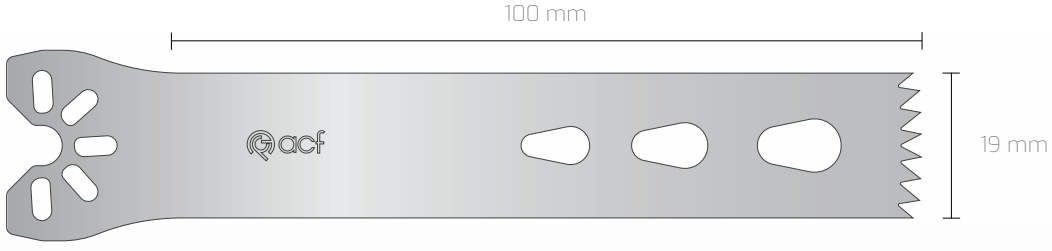

● Non Steril
● Steril R

Ref	100 190 100 127	100 190 100 130	100 190 100 137	100 190 100 140	100 190 100 147
Kalınlık	1,27 mm	1,30 mm	1,37 mm	1,40 mm	1,47 mm

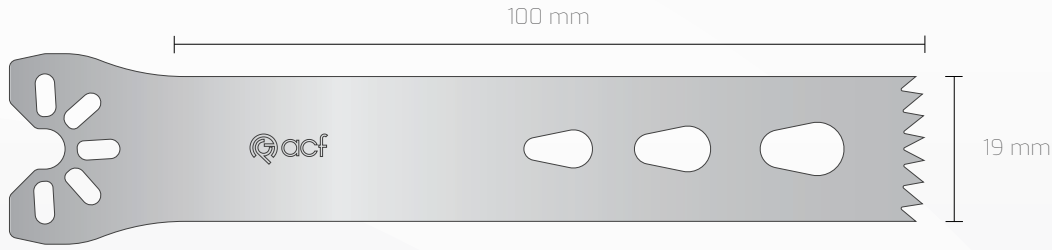

● Non Steril
● Steril R

Ref	100 190 100 150
Kalınlık	1,50 mm

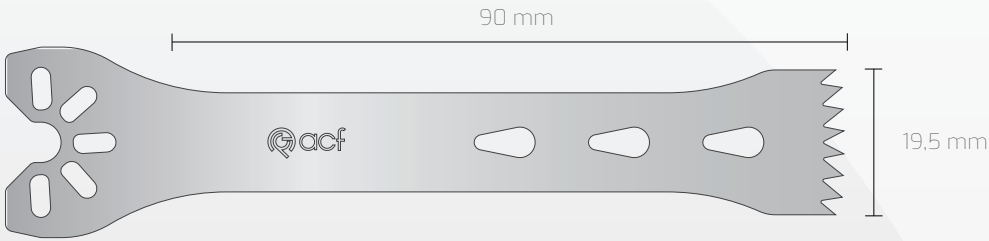

● Non Steril
● Steril R

Ref	100 195 090 089	100 195 090 090	100 195 090 100	100 195 090 119	100 195 090 120
Kalınlık	0,89 mm	0,90 mm	1,00 mm	1,19 mm	1,20 mm

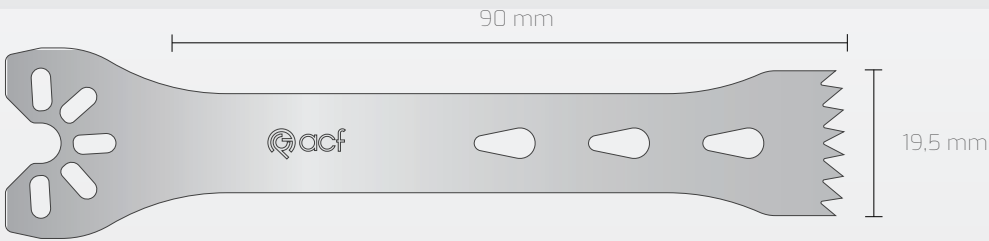

● Non Steril
● Steril R

Ref	100 195 090 127	100 195 090 130	100 195 090 137	100 195 090 140	100 195 090 147
Kalınlık	1,27 mm	1,30 mm	1,37 mm	1,40 mm	1,47 mm

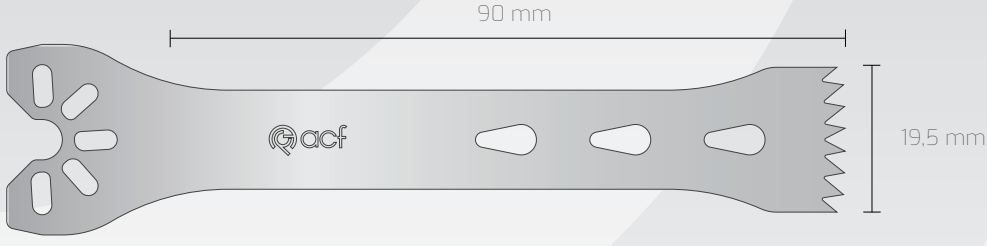

● Non Steril
● Steril R

Ref 100 195 090 150
Kalınlık 1,50 mm

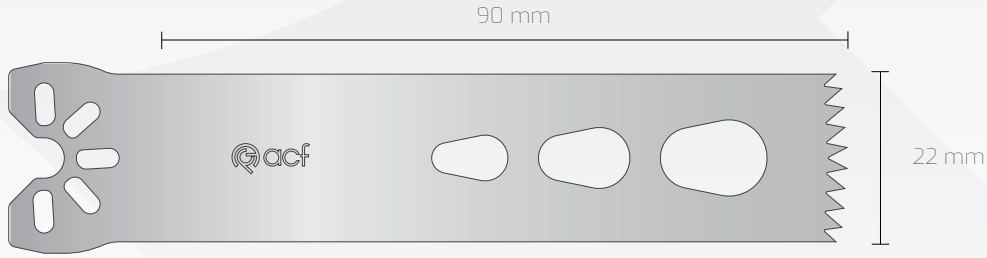

● Non Steril
● Steril R

Ref	100 220 090 089	100 220 090 090	100 220 090 100	100 220 090 119	100 220 090 120
Kalınlık	0,89 mm	0,90 mm	1,00 mm	1,19 mm	1,20 mm

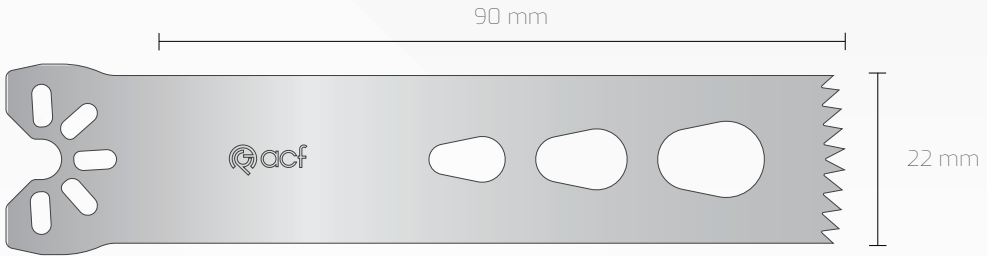

● Non Steril
● Steril R

Ref	100 220 090 127	100 220 090 130	100 220 090 137	100 220 090 140	100 220 090 147
Kalınlık	1,27 mm	1,30 mm	1,37 mm	1,40 mm	1,47 mm

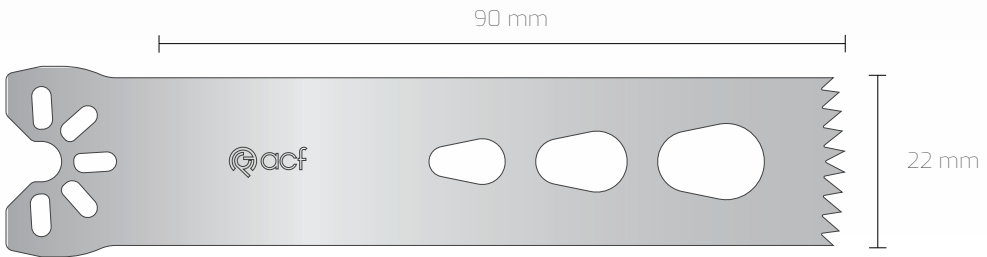

● Non Steril
● Steril R

Ref 100 220 090 150
Kalınlık 1,50 mm

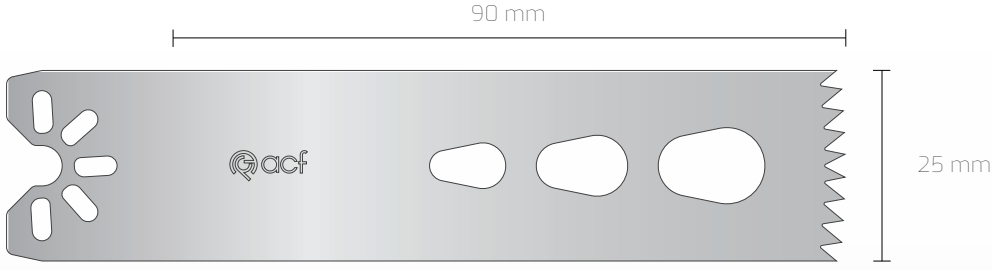

● Non Steril
● Steril R

Ref	100 250 090 089	100 250 090 090	100 250 090 100	100 250 090 119	100 250 090 120
Kalınlık	0,89 mm	0,90 mm	1,00 mm	1,19 mm	1,20 mm

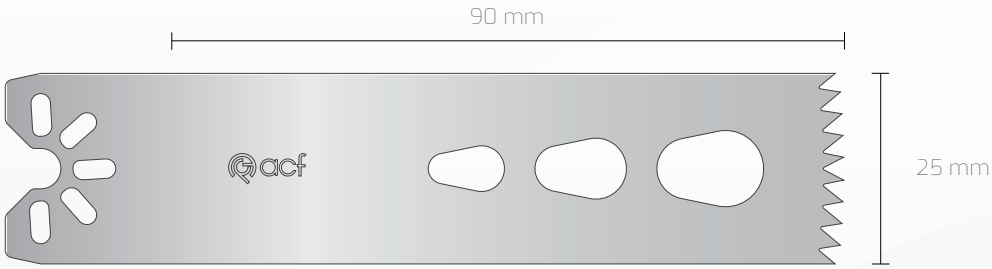

● Non Steril
● Steril R

Ref	100 250 090 127	100 250 090 130	100 250 090 137	100 250 090 140	100 250 090 147
Kalınlık	1,27 mm	1,30 mm	1,37 mm	1,40 mm	1,47 mm

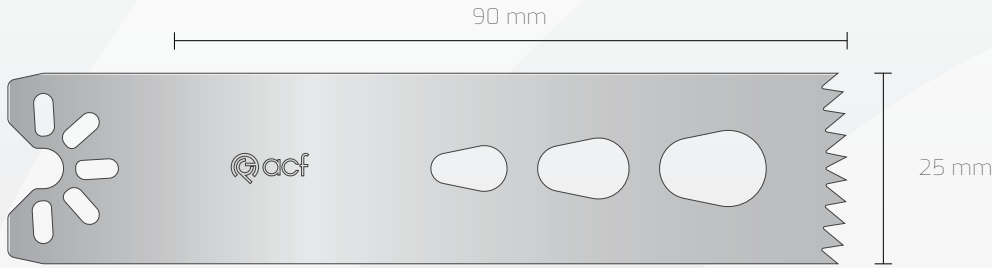

● Non Steril
● Steril R

Ref	100 250 090 150
Kalınlık	1,50 mm

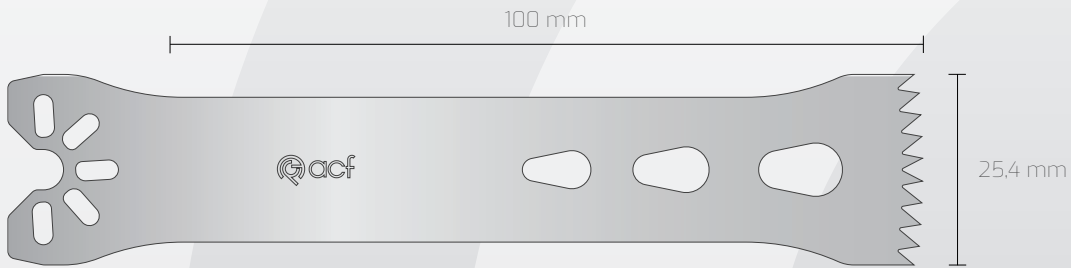

● Non Steril
● Steril R

Ref	100 254 100 089	100 254 100 090	100 254 100 100	100 254 100 119	100 254 100 120
Kalınlık	0,89 mm	0,90 mm	1,00 mm	1,19 mm	1,20 mm

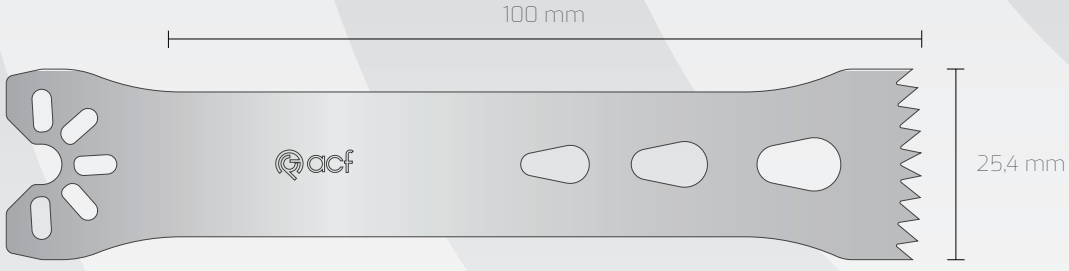

● Non Steril
● Steril R

Ref	100 254 100 127	100 254 100 130	100 254 100 137	100 254 100 140	100 254 100 147
Kalınlık	1,27 mm	1,30 mm	1,37 mm	1,40 mm	1,47 mm

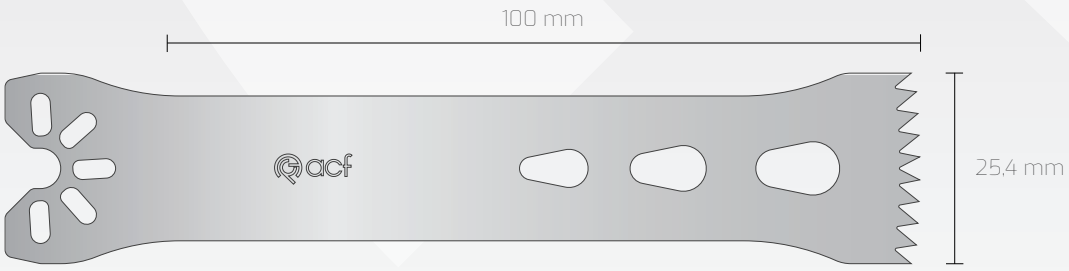

● Non Steril
● Steril R

Ref	100 254 100 150
Kalınlık	1,50 mm

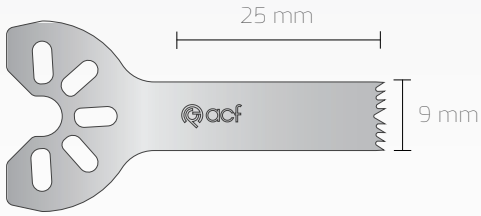

● Non Steril
● Steril R

Ref	100 090 025 060
Kalınlık	0,60 mm

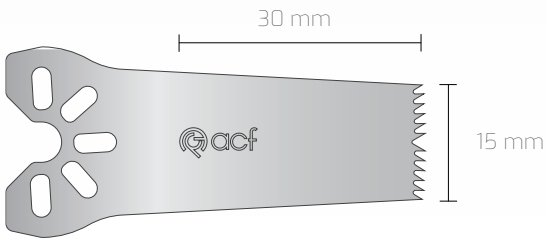

● Non Steril
● Steril R

Ref	100 150 030 060
Kalınlık	0,60 mm

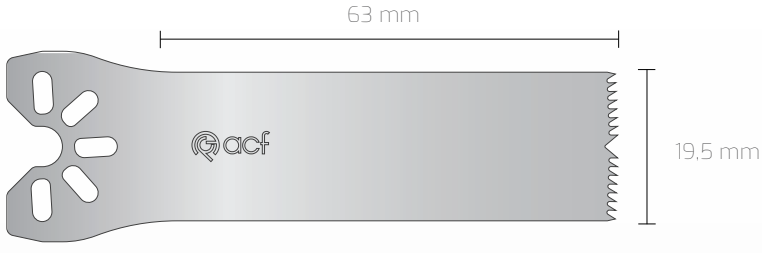

● Non Steril
● Steril R

Ref 100 195 063 060
Kalınlık 0,60 mm

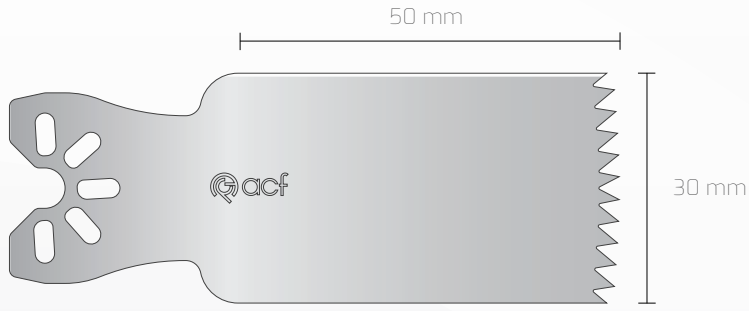

● Non Steril
● Steril R

Ref 100 300 050 090 100 300 050 100
Kalınlık 0,90 mm 1,00 mm

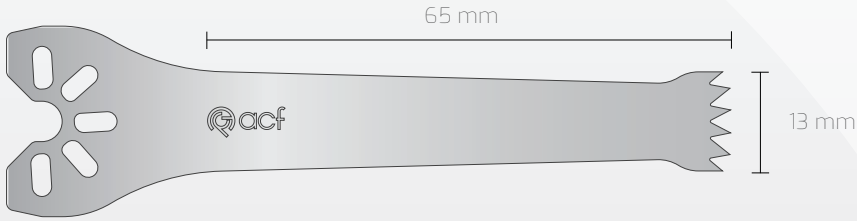

● Non Steril
● Steril R

Ref 100 130 065 090
Kalınlık 0,90 mm

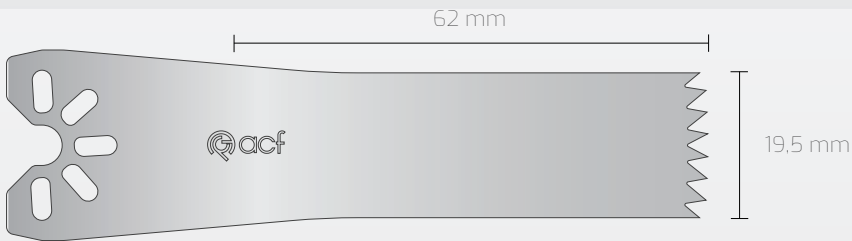

● Non Steril
● Steril R

Ref 100 195 062 090
Kalınlık 0,90 mm

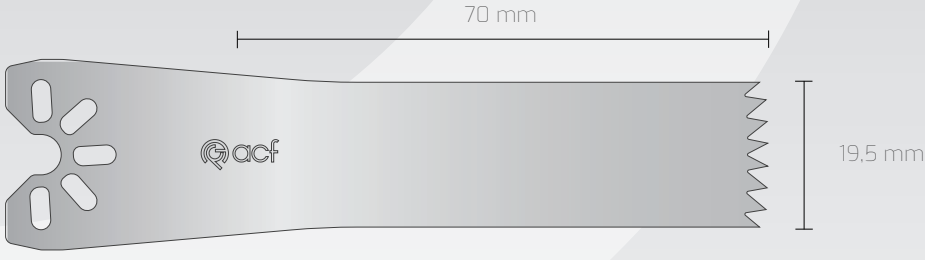

● Non Steril
● Steril R

Ref 100 195 070 090
Kalınlık 0,90 mm

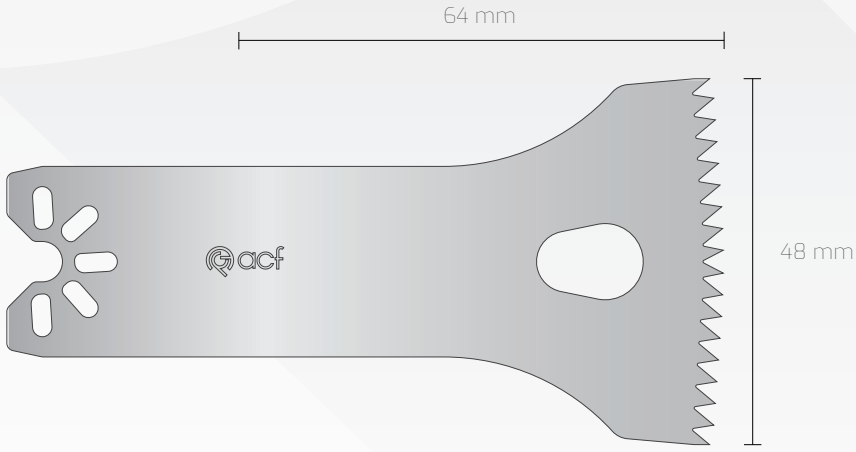

● Non Steril
● Steril R

Ref 100 480 064 090
Kalınlık 0,90 mm

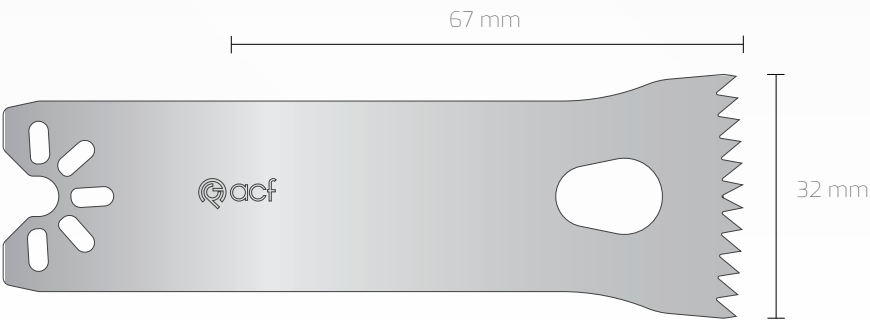

● Non Steril
● Steril R

Ref 100 320 067 090
Kalınlık 0,90 mm

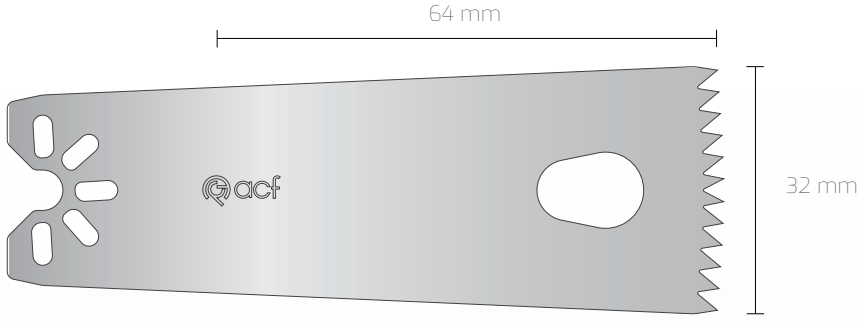

● Non Steril
● Steril R

Ref 100 320 064 090
Kalınlık 0,90 mm

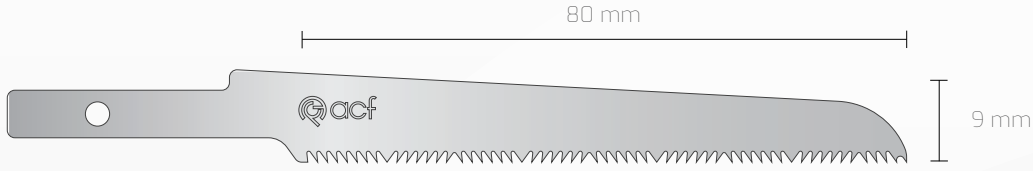

● Non Steril
● Steril R

Ref 100 090 080 060
Kalınlık 0,60 mm

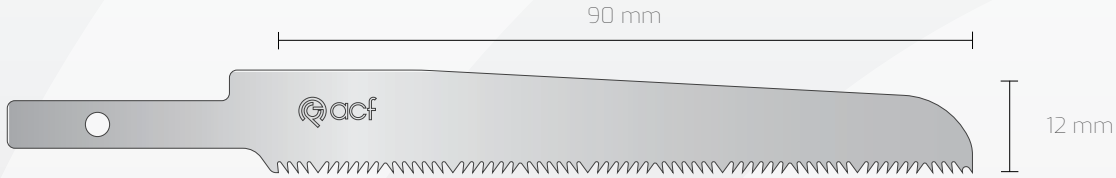

● Non Steril
● Steril R

Ref 100 120 090 060 100 120 090 090
Kalınlık 0,60 mm 0,90 mm

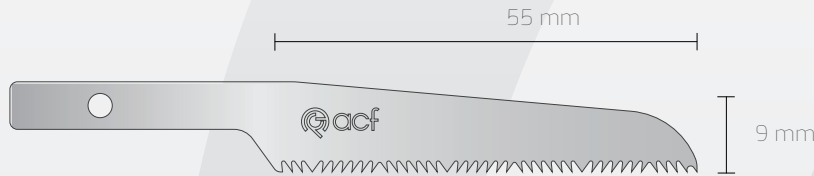

● Non Steril
● Steril R

Ref 100 090 055 060 100 090 055 090
Kalınlık 0,60 mm 0,90 mm

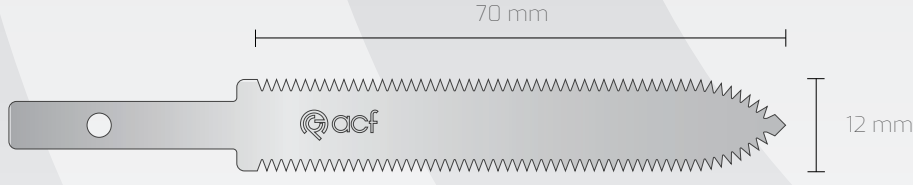

● Non Steril
● Steril R

Ref	100 120 070 060	100 120 070 090	100 120 070 100	100 120 070 120
Kalınlık	0,60 mm	0,90 mm	1,00 mm	1,20 mm

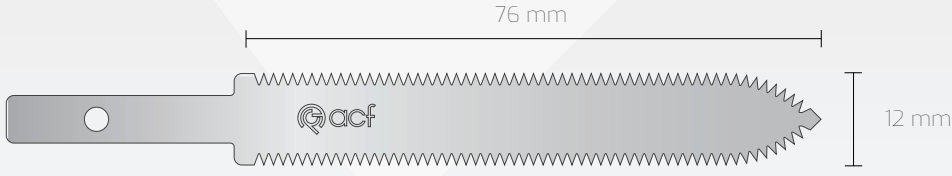

● Non Steril
● Steril R

Ref	100 120 076 060	100 120 076 090	100 120 076 100	100 120 076 120
Kalınlık	0,60 mm	0,90 mm	1,00 mm	1,20 mm

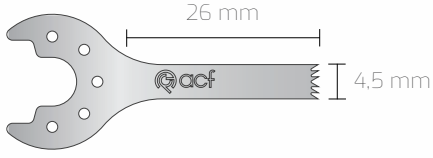

● Non Steril
 ● Steril R

Ref 100 045 026 060
 Kalınlık 0,60 mm

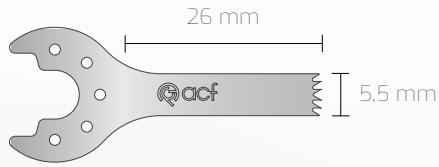

● Non Steril
 ● Steril R

Ref 100 055 026 060
 Kalınlık 0,60 mm

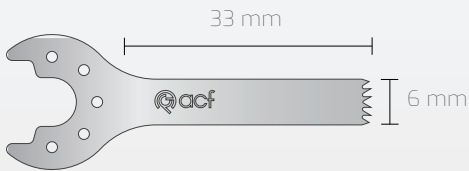

● Non Steril
 ● Steril R

Ref 100 060 033 060
 Kalınlık 0,60 mm



● Non Steril
 ● Steril R

Ref 100 100 030 060
 Kalınlık 0,60 mm

Microaire®

Uyumlu Modeller;

1950, 1955, 2250, 6670,
6672, 6673 sagittal saws



● Non Steril
● Steril R

Ref 100 100 033 060

Kalınlık 0,60 mm

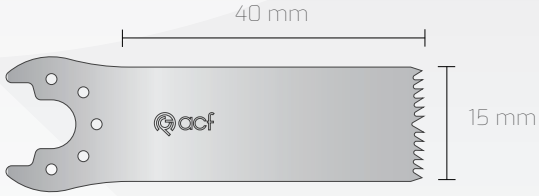

● Non Steril
● Steril R

Ref 100 150 040 060

Kalınlık 0,60 mm

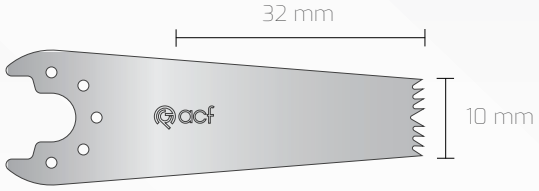

● Non Steril
● Steril R

Ref 100 100 032 060

Kalınlık 0,60 mm

MICROAIRE®



**STRYKER®
ile Uyumlu
Testere Bıçaklar**



Marka Kodu **120**

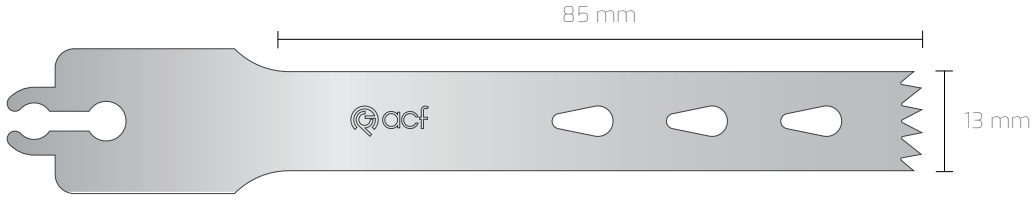

● Non Steril
 ● Steril R

Ref	120 130 085 089	120 130 085 090	120 130 085 100	120 130 085 119	120 130 085 120
Kalınlık	0,89 mm	0,90 mm	1,00 mm	1,19 mm	1,20 mm

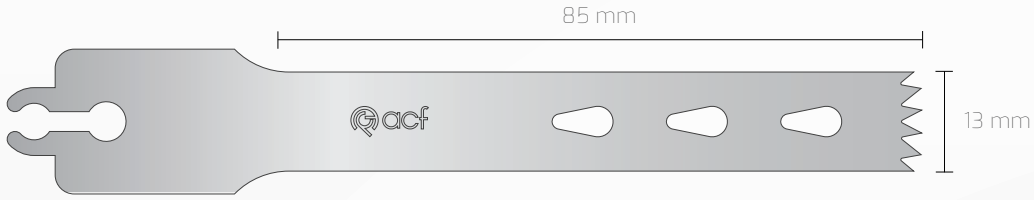

● Non Steril
 ● Steril R

Ref	120 130 085 127	120 130 085 130	120 130 085 137	120 130 085 140	120 130 085 147
Kalınlık	1,27 mm	1,30 mm	1,37 mm	1,40 mm	1,47 mm

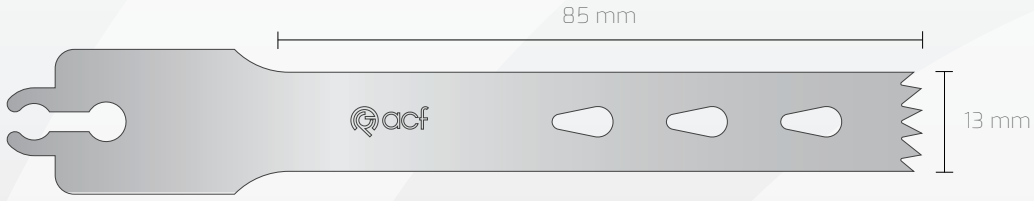

● Non Steril
 ● Steril R

Ref	120 130 085 150
Kalınlık	1,50 mm

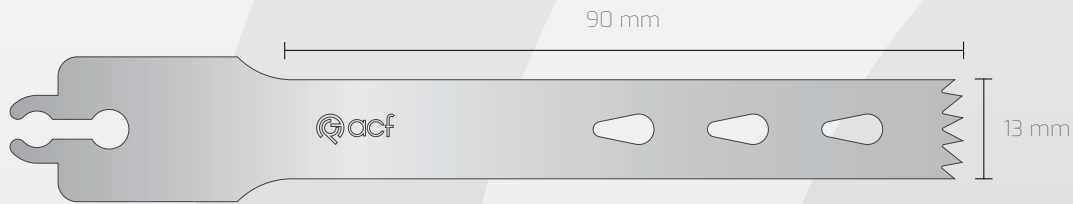

● Non Steril
 ● Steril R

Ref	120 130 090 089	120 130 090 090	120 130 090 100	120 130 090 119	120 130 090 120
Kalınlık	0,89 mm	0,90 mm	1,00 mm	1,19 mm	1,20 mm

Stryker®

Uyumlu Modeller;

Stryker System EHD(296-98),
2000(2108), 54(4108), 55(4208),
56(6208), 57(7208), 58(8208)

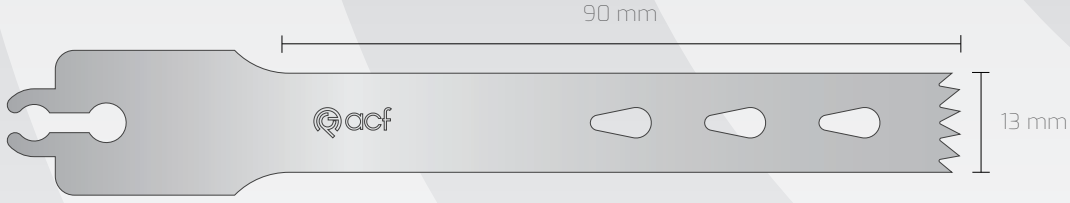

● Non Steril
● Steril R

Ref	120 130 090 127	120 130 090 130	120 130 090 137	120 130 090 140	120 130 090 147
Kalınlık	1,27 mm	1,30 mm	1,37 mm	1,40 mm	1,47 mm

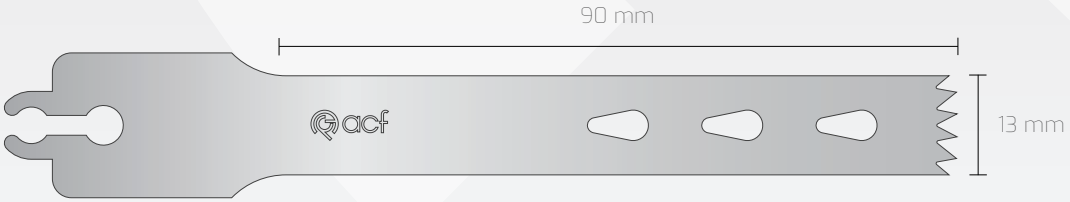

● Non Steril
● Steril R

Ref	120 130 090 150
Kalınlık	1,50 mm

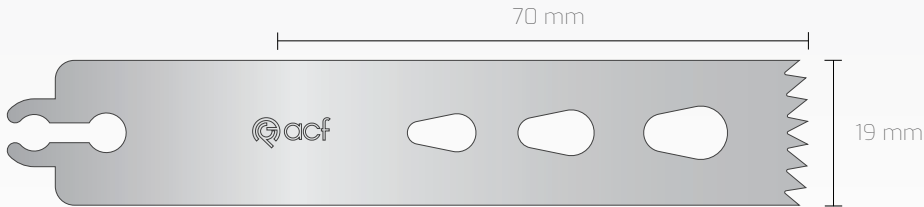

● Non Steril
● Steril R

Ref	120 190 070 120
Kalınlık	1,20 mm

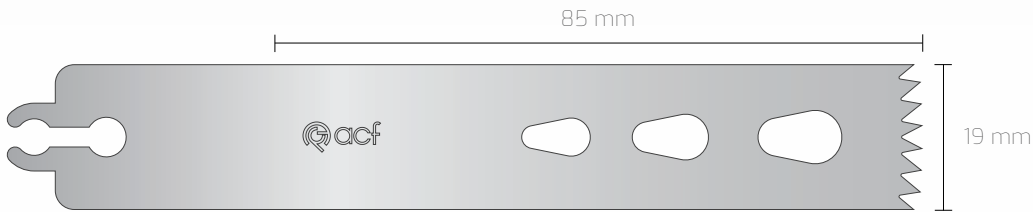

● Non Steril
● Steril R

Ref	120 190 085 089	120 190 085 090	120 190 085 100	120 190 085 119	120 190 085 120
Kalınlık	0,89 mm	0,90 mm	1,00 mm	1,19 mm	1,20 mm

Tüm testere bıçaklar gerçek ölçülerinde gösterilmiştir. 1:1

STRYKER®

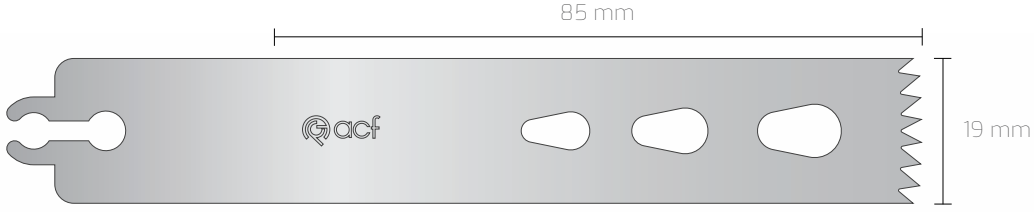

● Non Steril
 ● Steril R

Ref	120 190 085 127	120 190 085 130	120 190 085 137	120 190 085 140	120 190 085 147
Kalınlık	1,27 mm	1,30 mm	1,37 mm	1,40 mm	1,47 mm

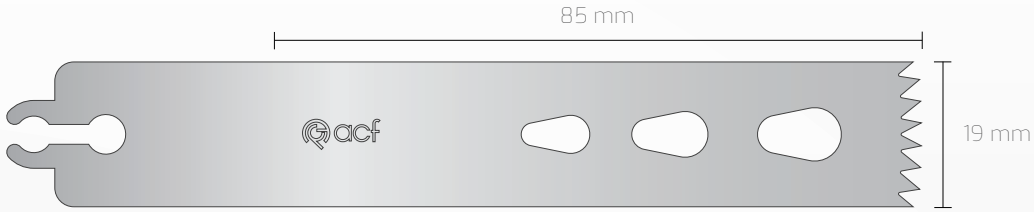

● Non Steril
 ● Steril R

Ref	120 190 085 150
Kalınlık	1,50 mm

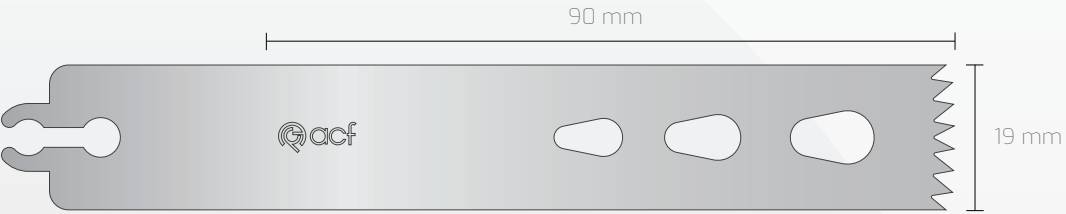

● Non Steril
 ● Steril R

Ref	120 190 090 089	120 190 090 090	120 190 090 100	120 190 090 119	120 190 090 120
Kalınlık	0,89 mm	0,90 mm	1,00 mm	1,19 mm	1,20 mm

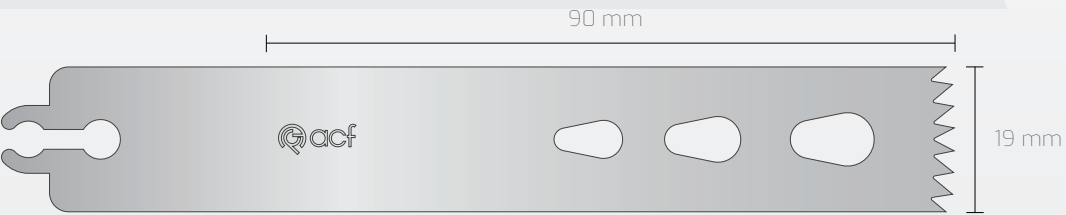

● Non Steril
 ● Steril R

Ref	120 190 090 127	120 190 090 130	120 190 090 137	120 190 090 140	120 190 090 147
Kalınlık	1,27 mm	1,30 mm	1,37 mm	1,40 mm	1,47 mm

Stryker®

Uyumlu Modeller;

Stryker System EHD(296-98),
2000(2108), 54(4108), 55(4208),
56(6208), 57(7208), 58(8208)

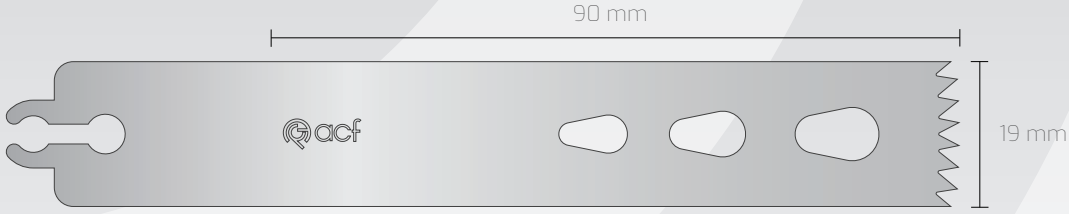

● Non Steril
● Steril R

Ref 120 190 090 150

Kalınlık 1,50 mm

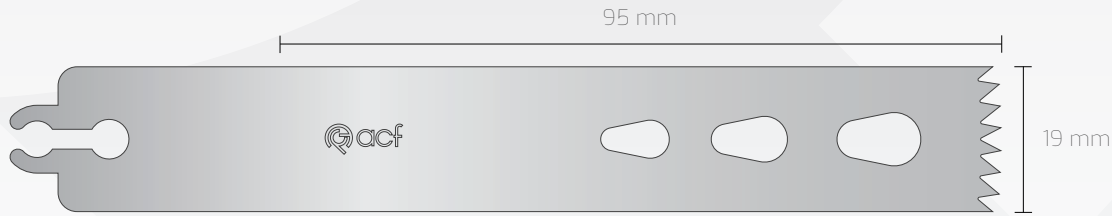

● Non Steril
● Steril R

Ref 120 190 095 100

Kalınlık 1,00 mm

Ref 120 190 095 120

Kalınlık 1,20 mm

Ref 120 190 095 127

Kalınlık 1,27 mm

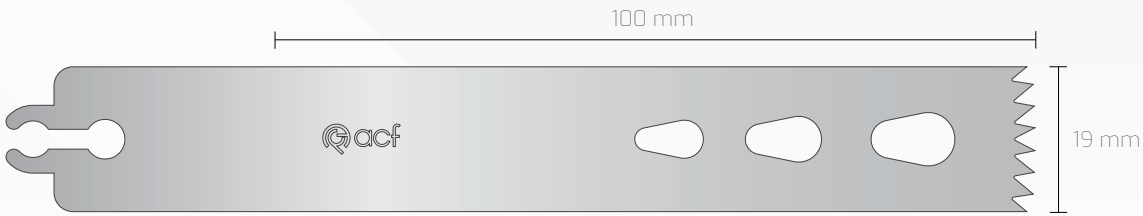

● Non Steril
● Steril R

Ref 120 190 100 089

Kalınlık 0,89 mm

Ref 120 190 100 090

Kalınlık 0,90 mm

Ref 120 190 100 100

Kalınlık 1,00 mm

Ref 120 190 100 119

Kalınlık 1,19 mm

Ref 120 190 100 120

Kalınlık 1,20 mm

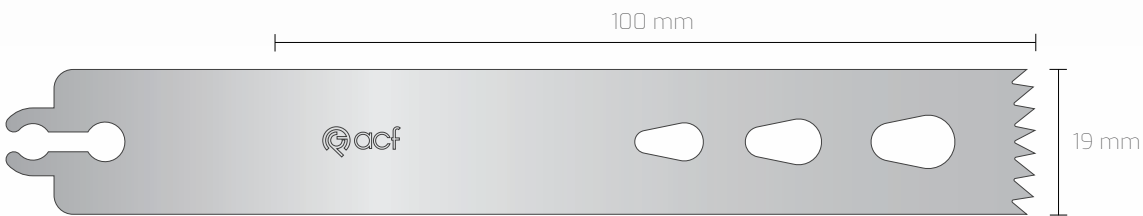

● Non Steril
● Steril R

Ref 120 190 100 127

Kalınlık 1,27 mm

Ref 120 190 100 130

Kalınlık 1,30 mm

Ref 120 190 100 137

Kalınlık 1,37 mm

Ref 120 190 100 140

Kalınlık 1,40 mm

Ref 120 190 100 147

Kalınlık 1,47 mm

Tüm testere bıçaklar gerçek ölçülerinde gösterilmiştir. 1:1

STRYKER®

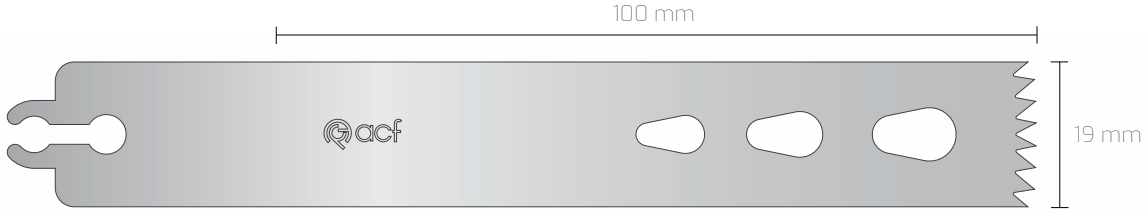

● Non Steril
● Steril R

Ref 120 190 100 150

Kalınlık 1,50 mm

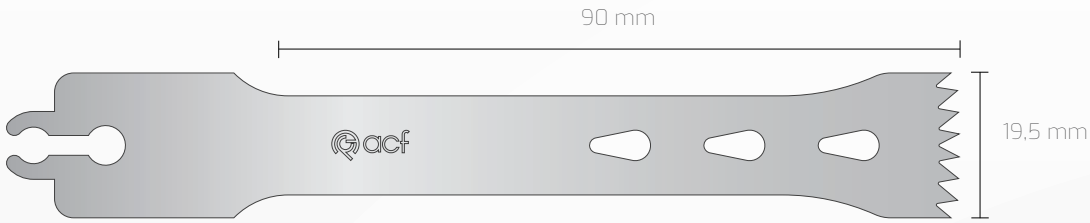

● Non Steril
● Steril R

Ref	120 195 090 089	120 195 090 090	120 195 090 100	120 195 090 119	120 195 090 120
Kalınlık	0,89 mm	0,90 mm	1,00 mm	1,19 mm	1,20 mm

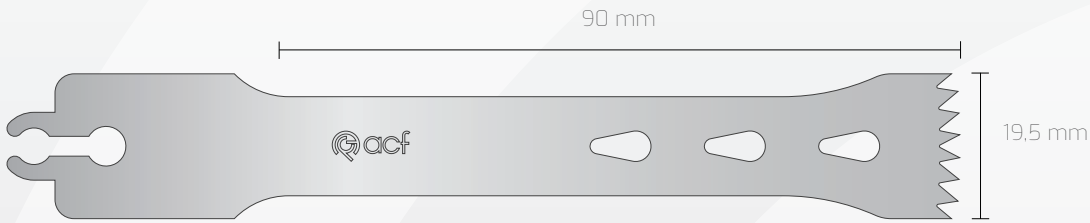

● Non Steril
● Steril R

Ref	120 195 090 127	120 195 090 130	120 195 090 137	120 195 090 140	120 195 090 147
Kalınlık	1,27 mm	1,30 mm	1,37 mm	1,40 mm	1,47 mm

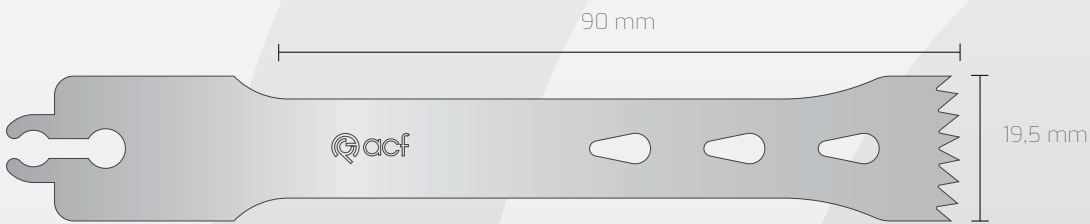

● Non Steril
● Steril R

Ref 120 195 090 150

Kalınlık 1,50 mm

Stryker®

Uyumlu Modeller;

Stryker System EHD(296-98),
2000(2108), 54(4108), 55(4208),
56(6208), 57(7208), 58(8208)

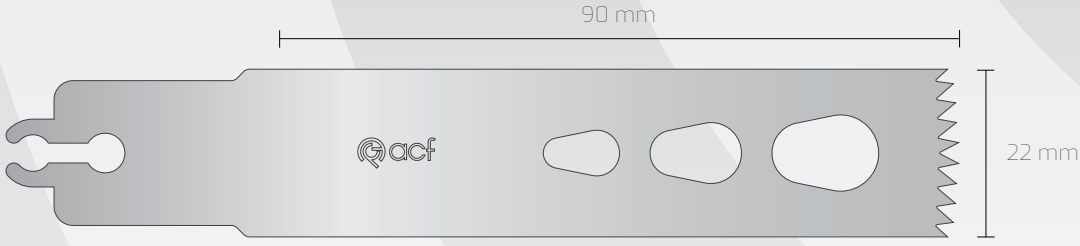

● Non Steril
● Steril R

Ref	120 220 090 089	120 220 090 090	120 220 090 100	120 220 090 119	120 220 090 120
Kalınlık	0,89 mm	0,90 mm	1,00 mm	1,19 mm	1,20 mm

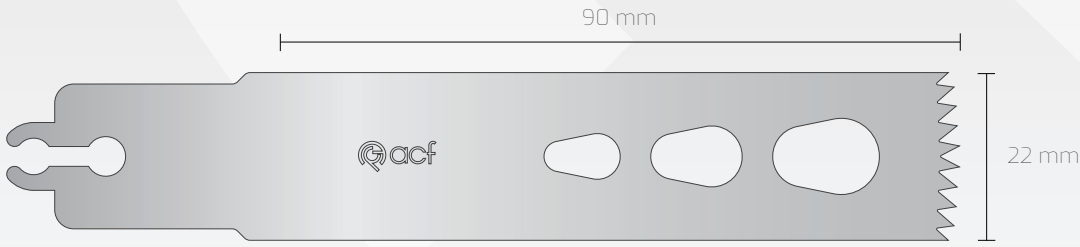

● Non Steril
● Steril R

Ref	120 220 090 127	120 220 090 130	120 220 090 137	120 220 090 140	120 220 090 147
Kalınlık	1,27 mm	1,30 mm	1,37 mm	1,40 mm	1,47 mm

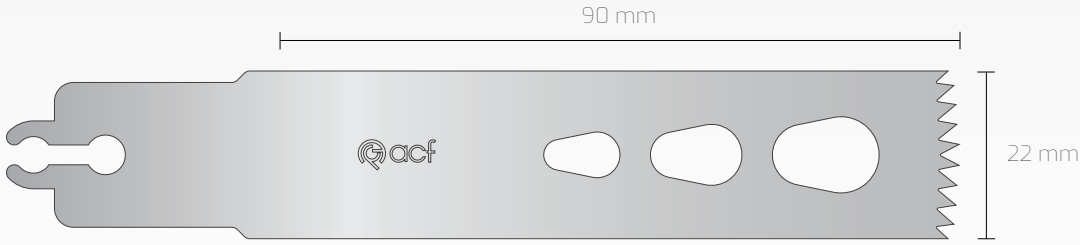

● Non Steril
● Steril R

Ref	120 220 090 150
Kalınlık	1,50 mm

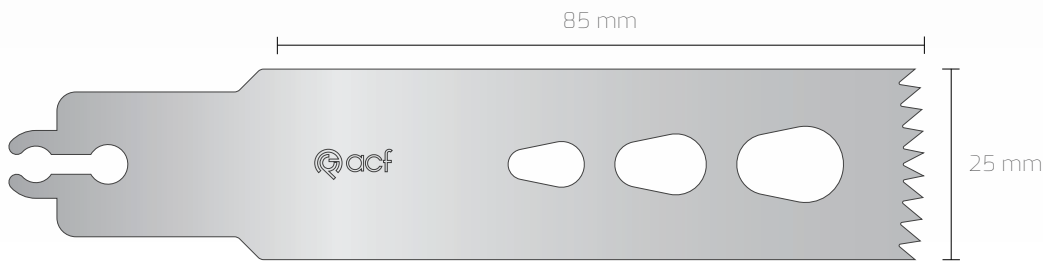

● Non Steril
● Steril R

Ref	120 250 085 089	120 250 085 090	120 250 085 100	120 250 085 119	120 250 085 120
Kalınlık	0,89 mm	0,90 mm	1,00 mm	1,19 mm	1,20 mm

Tüm testere bıçaklar gerçek ölçülerinde gösterilmiştir. 1:1

STRYKER®

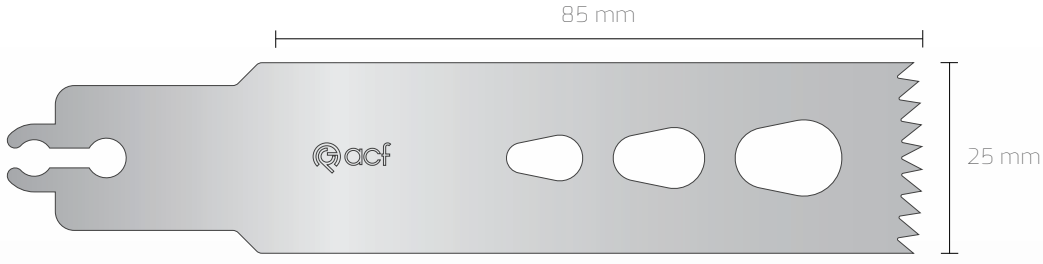

● Non Steril
● Steril R

Ref	120 250 085 127	120 250 085 130	120 250 085 137	120 250 085 140	120 250 085 147
Kalınlık	1,27 mm	1,30 mm	1,37 mm	1,40 mm	1,47 mm

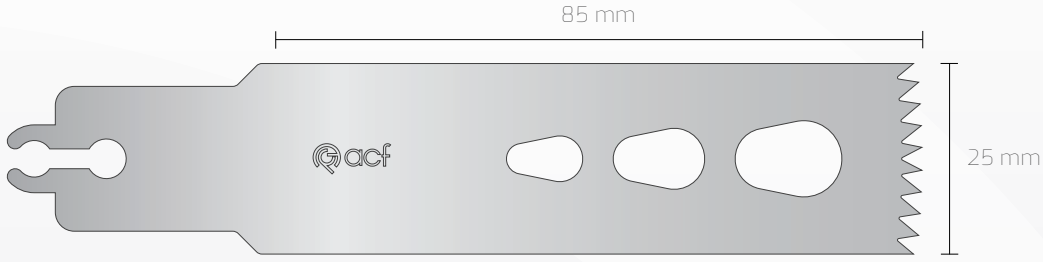

● Non Steril
● Steril R

Ref	120 250 085 150
Kalınlık	1,50 mm

Stryker®

Uyumlu Modeller;

Stryker System EHD(296-98),
2000(2108), 54(4108), 55(4208),
56(6208), 57(7208), 58(8208)

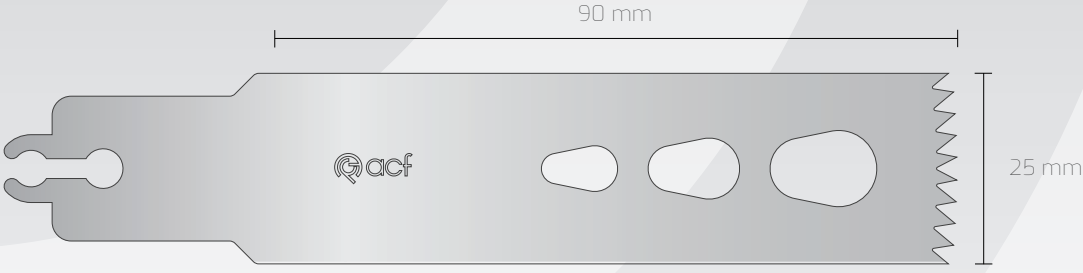

● Non Steril
● Steril R

Ref	120 250 090 089	120 250 090 090	120 250 090 100	120 250 090 119	120 250 090 120
Kalınlık	0,89 mm	0,90 mm	1,00 mm	1,19 mm	1,20 mm

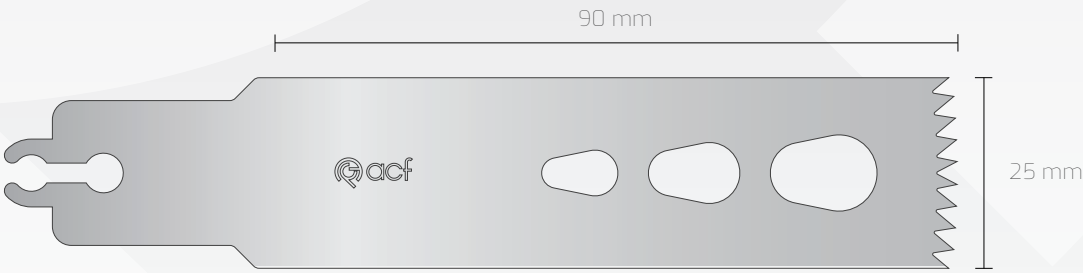

● Non Steril
● Steril R

Ref	120 250 090 127	120 250 090 130	120 250 090 137	120 250 090 140	120 250 090 147
Kalınlık	1,27 mm	1,30 mm	1,37 mm	1,40 mm	1,47 mm

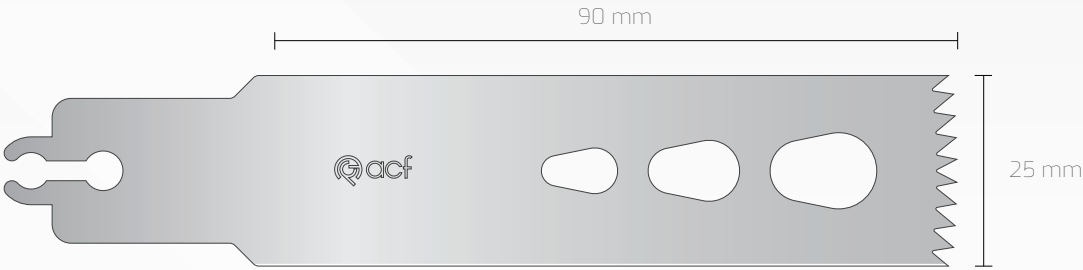

● Non Steril
● Steril R

Ref	120 250 090 150
Kalınlık	1,50 mm

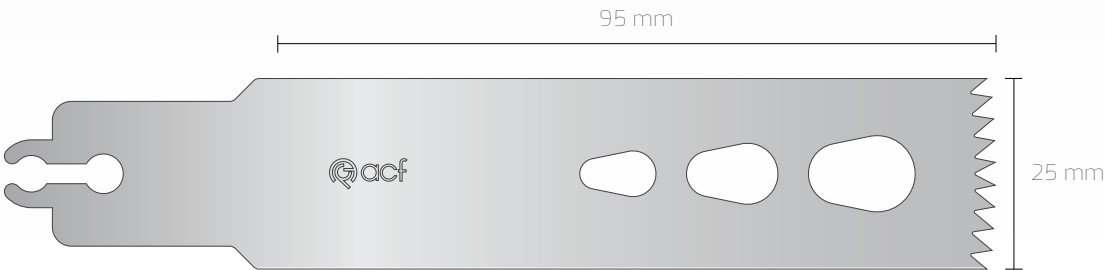

● Non Steril
● Steril R

Ref	120 250 095 100	120 250 095 120	120 250 095 127
Kalınlık	1,00 mm	1,20 mm	1,27 mm

Tüm testere bıçaklar gerçek ölçülerinde gösterilmiştir. 1:1

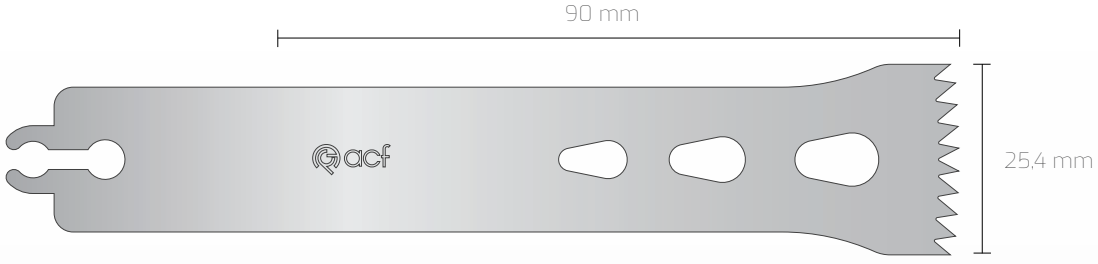

● Non Steril
● Steril R

Ref	120 254 090 089	120 254 090 090	120 254 090 100	120 254 090 119	120 254 090 120
Kalınlık	0,89 mm	0,90 mm	1,00 mm	1,19 mm	1,20 mm

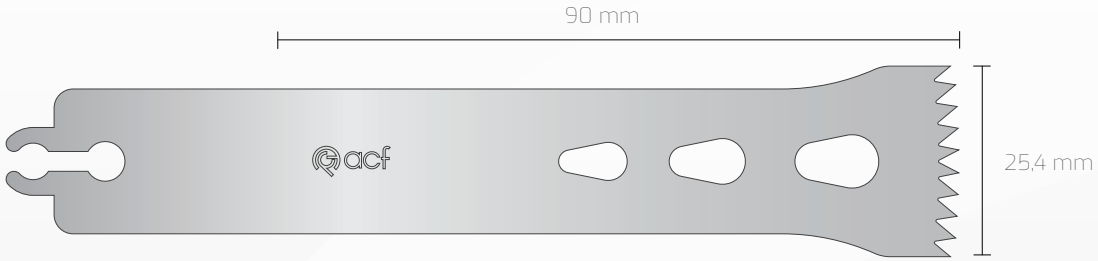

● Non Steril
● Steril R

Ref	120 254 090 127	120 254 090 130	120 254 090 137	120 254 090 140	120 254 090 147
Kalınlık	1,27 mm	1,30 mm	1,37 mm	1,40 mm	1,47 mm

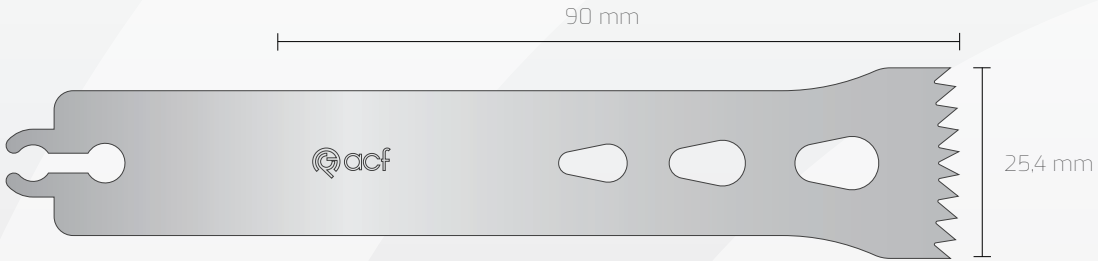

● Non Steril
● Steril R

Ref	120 254 090 150
Kalınlık	1,50 mm

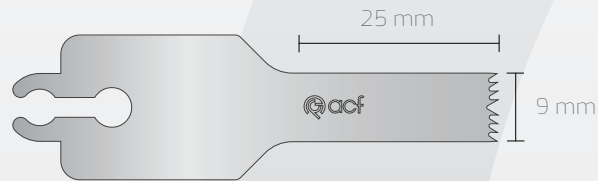

● Non Steril
● Steril R

Ref	120 090 025 060
Kalınlık	0,60 mm

Stryker®

Uyumlu Modeller;

Stryker System EHD(296-98),
2000(2108), 54(4108), 55(4208),
56(6208), 57(7208), 58(8208)

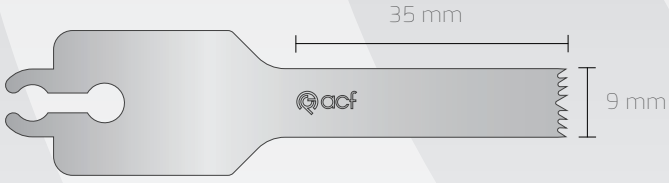

● Non Steril
● Steril R

Ref 120 090 035 060

Kalınlık 0,60 mm

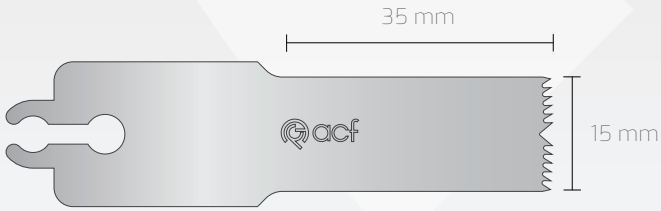

● Non Steril
● Steril R

Ref 120 150 035 060

Kalınlık 0,60 mm



● Non Steril
● Steril R

Ref 120 270 058 060

Kalınlık 0,60 mm

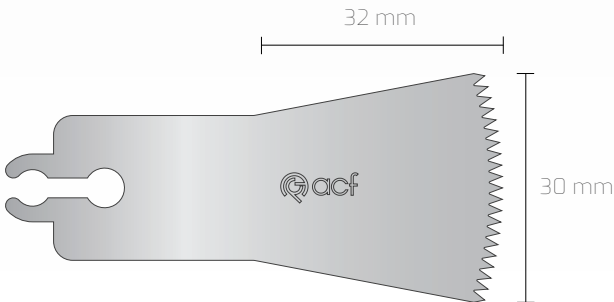

● Non Steril
● Steril R

Ref 120 300 032 060

Kalınlık 0,60 mm

STRYKER®

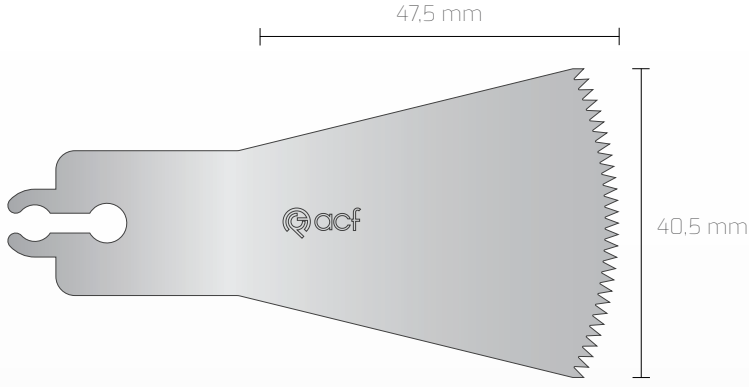
●
Non Steril●
Steril R**Ref** 120 405 475 060

Kalınlık 0,60 mm

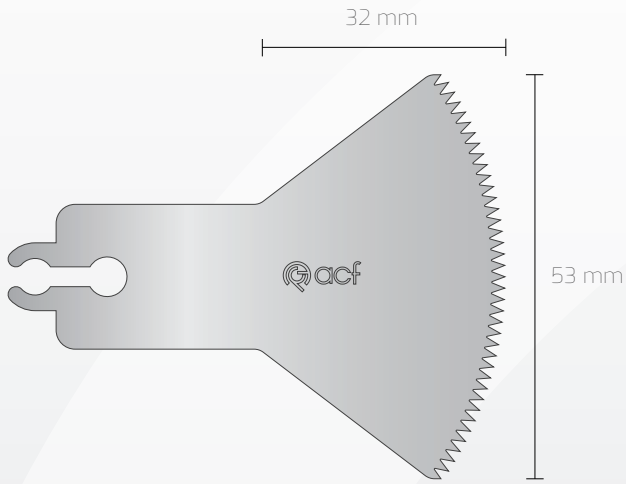
●
Non Steril●
Steril R**Ref** 120 530 032 060

Kalınlık 0,60 mm

Stryker®

Uyumlu Modeller;

Stryker System EHD(296-98),
2000(2108), 54(4108), 55(4208),
56(6208), 57(7208), 58(8208)

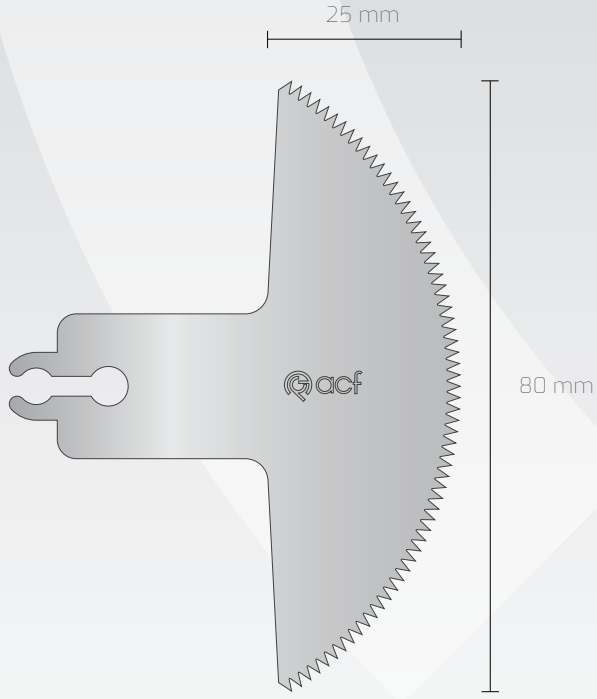

● Non Steril
● Steril R

Ref 120 800 025 060
Kalınlık 0,60 mm

STRYKER®



●
Non Steril

●
Steril R

Ref	120 060 032 060
Kalınlık	0,60 mm

Stryker®
Uyumlu Modeller;
4206, 4106, 2106, 296-96,
6206, 7206, 8206
Reciprocating Saws



● Non Steril
● Steril R

Ref 120 060 060 060
Kalınlık 0,60 mm

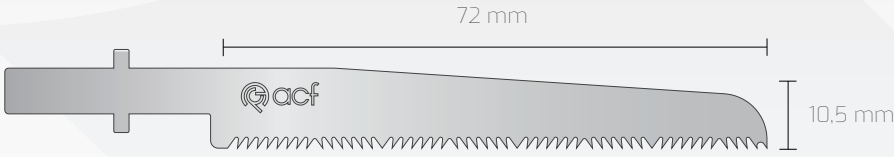

● Non Steril
● Steril R

Ref 120 105 072 060 120 105 072 090 120 105 072 100 120 105 072 120
Kalınlık 0,60 mm 0,90 mm 1,00 mm 1,20 mm

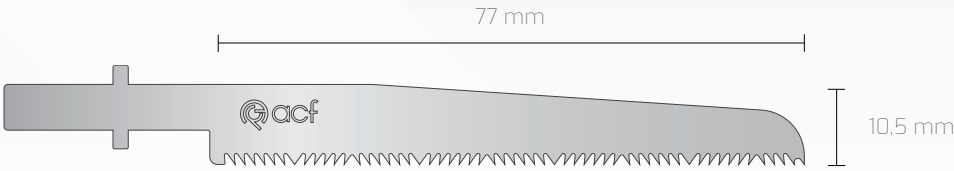

● Non Steril
● Steril R

Ref 120 105 077 060 120 105 077 090 120 105 077 100 120 105 077 120
Kalınlık 0,60 mm 0,90 mm 1,00 mm 1,20 mm

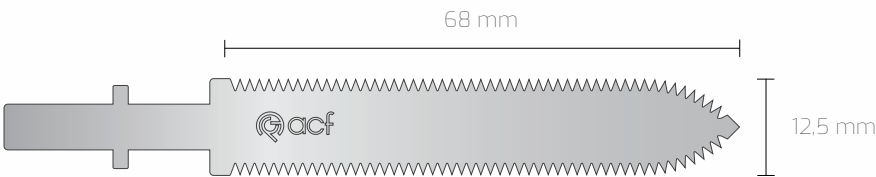

● Non Steril
● Steril R

Ref 120 125 068 090 120 125 068 100 120 125 068 120
Kalınlık 0,90 mm 1,00 mm 1,20 mm

Tüm testere bıçaklar gerçek ölçülerinde gösterilmiştir. 1:1

STRYKER®

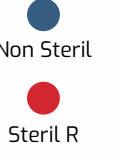
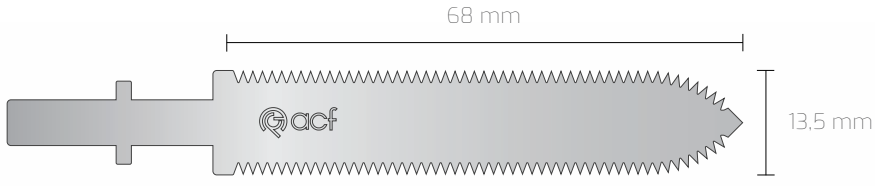

Ref	120 135 068 090	120 135 068 100	120 135 068 120
Kalınlık	0,90 mm	1,00 mm	1,20 mm

Stryker®

Uyumlu Modeller;

TPS5100-34 Sagittal Saw, TPS5100-31 Oscillating Saw, Command2 2296-31, 2296-234, 2296-34, 2296-231, 2296-080-134, Cordless Driver 2+3+4 Att. 4100-400, Sabo Sagittal Saw 4300-034, Sabo 2 4408-000, Micro Bone Saw, Core 5400-34, 5400-31, NSK Primado, RemB Micro Power 6400-034, 6400-031, 4100-400



● Non Steril
● Steril R

Ref 120 025 018 060
Kalınlık 0,60 mm

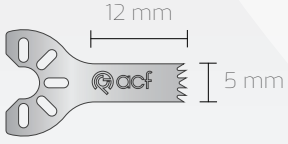

● Non Steril
● Steril R

Ref 120 050 012 060
Kalınlık 0,60 mm

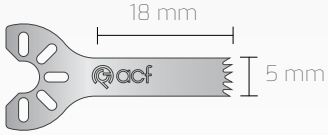

● Non Steril
● Steril R

Ref 120 050 018 060
Kalınlık 0,60 mm

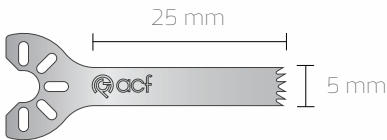

● Non Steril
● Steril R

Ref 120 050 025 060
Kalınlık 0,60 mm

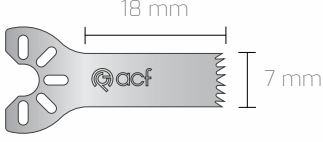

● Non Steril
● Steril R

Ref 120 070 018 060
Kalınlık 0,60 mm

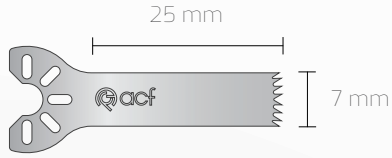

● Non Steril
● Steril R

Ref 120 070 025 060
Kalınlık 0,60 mm

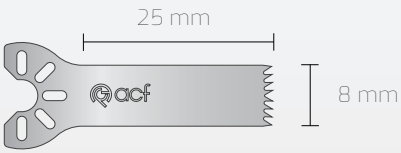

● Non Steril
● Steril R

Ref 120 080 025 060
Kalınlık 0,60 mm



● Non Steril
● Steril R

Ref 120 080 035 060
Kalınlık 0,60 mm

Stryker®

Uyumlu Modeller;

TP55100-34 Sagittal Saw, TP55100-31 Oscillating Saw, Command2 2296-31, 2296-234, 2296-34, 2296-231, 2296-080-134, Cordless Driver 2+3+4 Att. 4100-400, Sabo Sagittal Saw 4300-034, Sabo 2 4408-000, Micro Bone Saw, Core 5400-34, 5400-31, NSK Primado, RemB Micro Power 6400-034, 6400-031, 4100-400

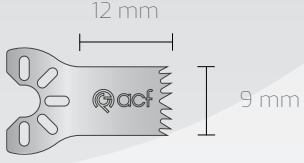

● Non Steril
● Steril R

Ref 120 090 012 060

Kalınlık 0,60 mm

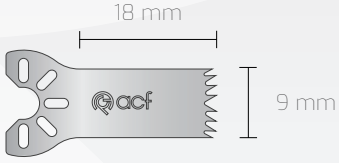

● Non Steril
● Steril R

Ref 120 090 018 060

Kalınlık 0,60 mm

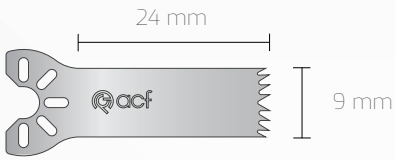

● Non Steril
● Steril R

Ref 120 090 024 060

Kalınlık 0,60 mm

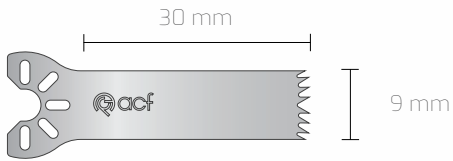

● Non Steril
● Steril R

Ref 120 090 030 060

Kalınlık 0,60 mm

STRYKER®

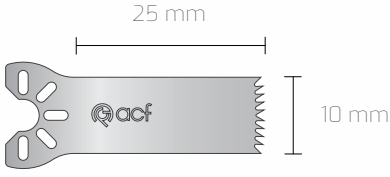

● Non Steril
● Steril R

Ref 120 100 025 060
Kalınlık 0,60 mm

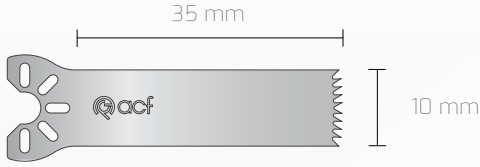

● Non Steril
● Steril R

Ref 120 100 035 060
Kalınlık 0,60 mm

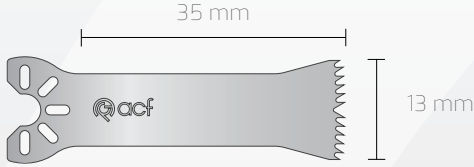

● Non Steril
● Steril R

Ref 120 130 035 060
Kalınlık 0,60 mm

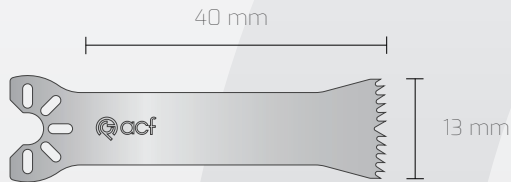

● Non Steril
● Steril R

Ref 120 130 040 060
Kalınlık 0,60 mm



CONMED LINVATEC® ile Uyumlu Testere Bıçaklar



Marka Kodu **140**

Dik Kesen Testere Bıçaklar ve Bazı Mikro Bıçaklar İçin
100

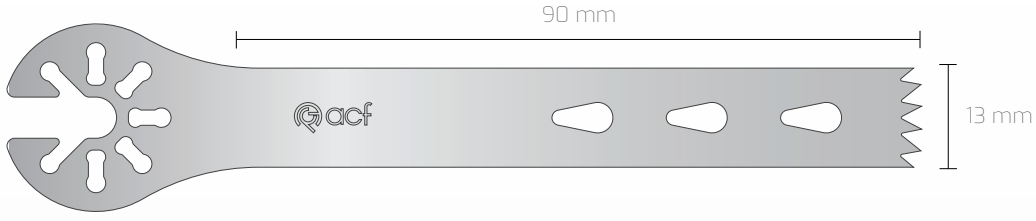

● Non Steril
● Steril R

Ref	140 130 090 089	140 130 090 090	140 130 090 100	140 130 090 119	140 130 090 120
Kalınlık	0,89 mm	0,90 mm	1,00 mm	1,19 mm	1,20 mm

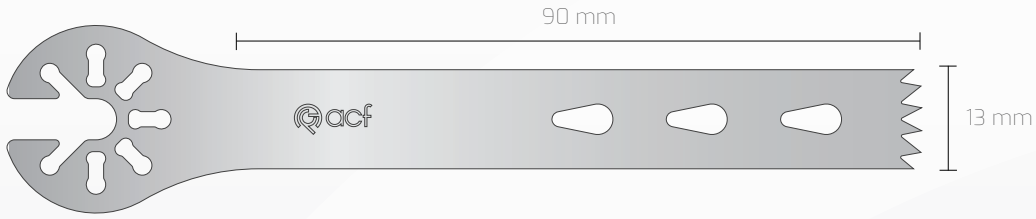

● Non Steril
● Steril R

Ref	140 130 090 127	140 130 090 130	140 130 090 137	140 130 090 140	140 130 090 147
Kalınlık	1,27 mm	1,30 mm	1,37 mm	1,40 mm	1,47 mm

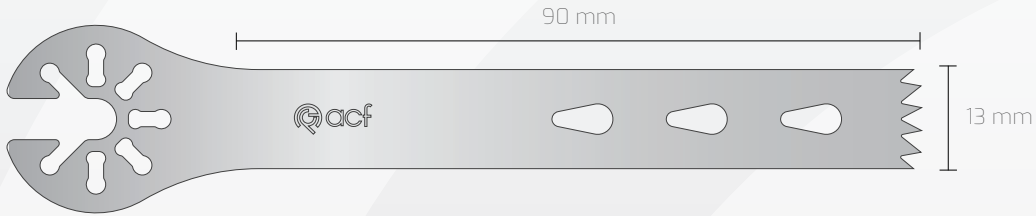

● Non Steril
● Steril R

Ref	140 130 090 150
Kalınlık	1,50 mm



● Non Steril
● Steril R

Ref	140 190 090 089	140 190 090 090	140 190 090 100	140 190 090 119	140 190 090 120
Kalınlık	0,89 mm	0,90 mm	1,00 mm	1,19 mm	1,20 mm

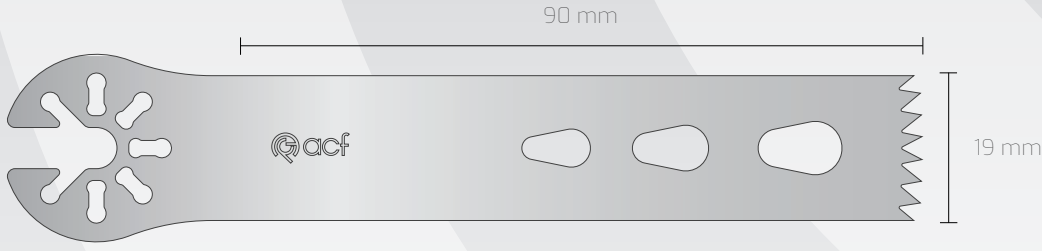

● Non Steril
● Steril R

Ref	140 190 090 127	140 190 090 130	140 190 090 137	140 190 090 140	140 190 090 147
Kalınlık	1,27 mm	1,30 mm	1,37 mm	1,40 mm	1,47 mm



● Non Steril
● Steril R

Ref	140 190 090 150
Kalınlık	1,50 mm

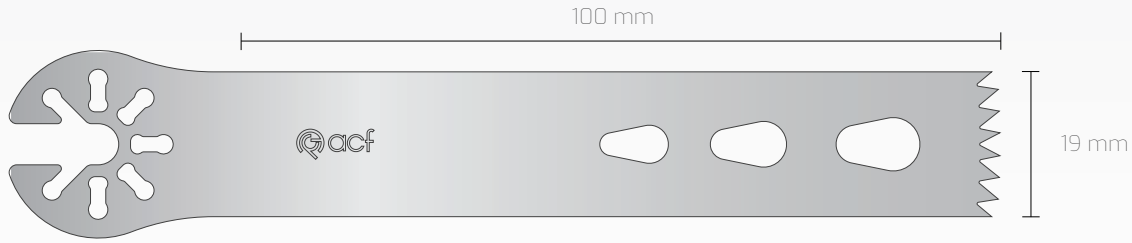

● Non Steril
● Steril R

Ref	140 190 100 089	140 190 100 090	140 190 100 100	140 190 100 119	140 190 100 120
Kalınlık	0,89 mm	0,90 mm	1,00 mm	1,19 mm	1,20 mm

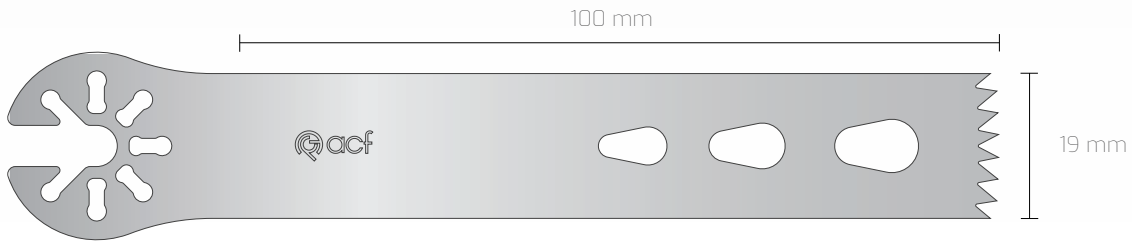

● Non Steril
● Steril R

Ref	140 190 100 127	140 190 100 130	140 190 100 137	140 190 100 140	140 190 100 147
Kalınlık	1,27 mm	1,30 mm	1,37 mm	1,40 mm	1,47 mm

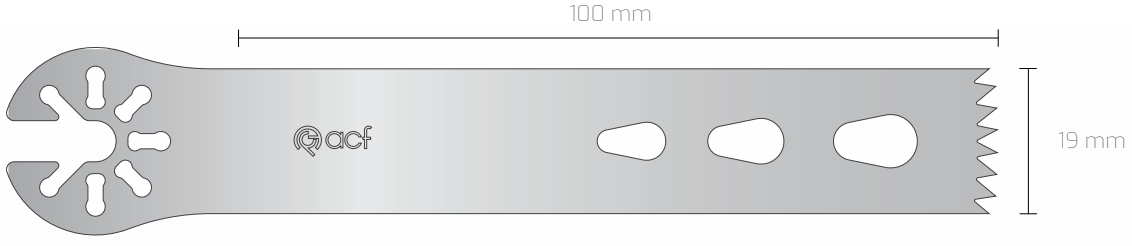

● Non Steril
● Steril R

Ref 140 190 100 150
Kalınlık 1,50 mm

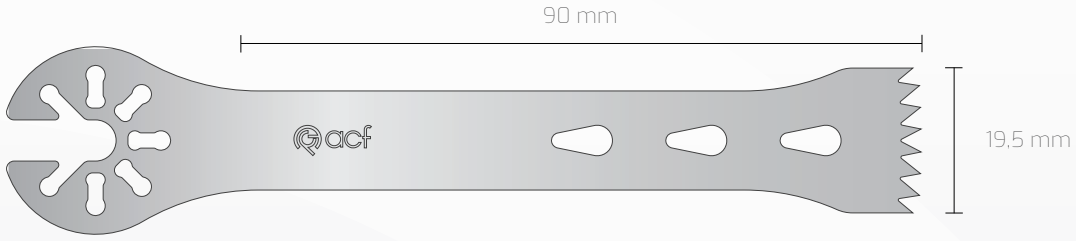

● Non Steril
● Steril R

Ref	140 195 090 089	140 195 090 090	140 195 090 100	140 195 090 119	140 195 090 120
Kalınlık	0,89 mm	0,90 mm	1,00 mm	1,19 mm	1,20 mm

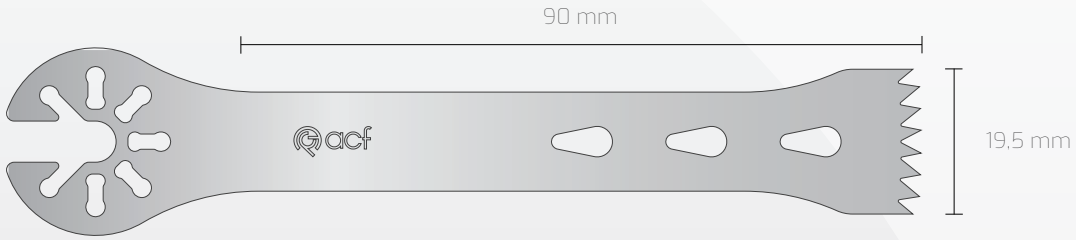

● Non Steril
● Steril R

Ref	140 195 090 127	140 195 090 130	140 195 090 137	140 195 090 140	140 195 090 147
Kalınlık	1,27 mm	1,30 mm	1,37 mm	1,40 mm	1,47 mm

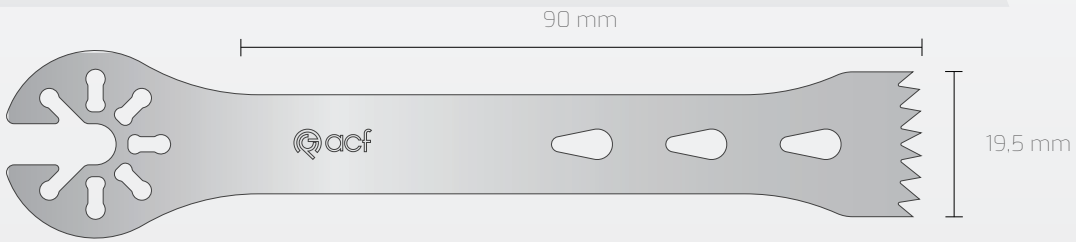

● Non Steril
● Steril R

Ref 140 195 090 150
Kalınlık 1,50 mm

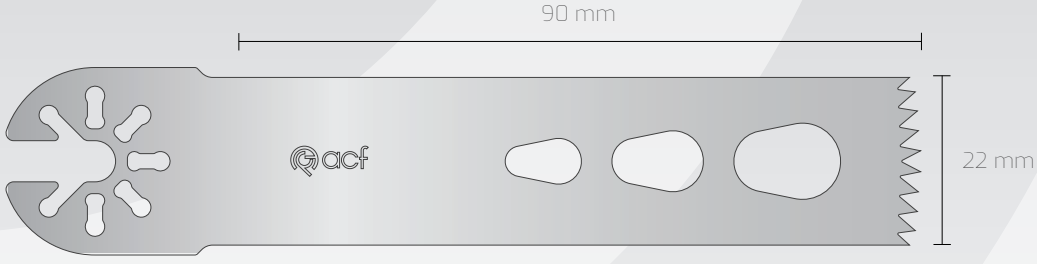

● Non Steril
● Steril R

Ref	140 220 090 089	140 220 090 090	140 220 090 100	140 220 090 119	140 220 090 120
Kalınlık	0,89 mm	0,90 mm	1,00 mm	1,19 mm	1,20 mm

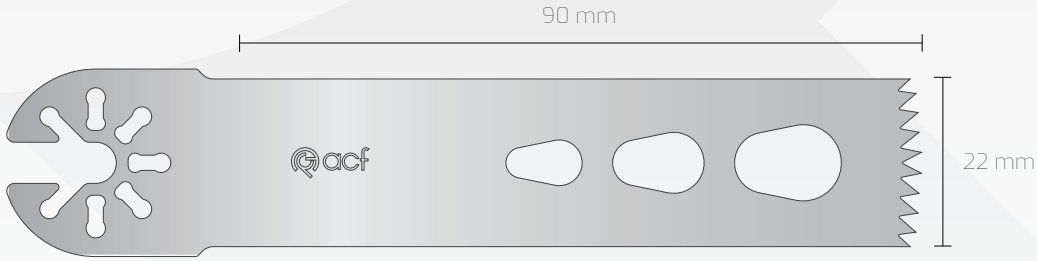

● Non Steril
● Steril R

Ref	140 220 090 127	140 220 090 130	140 220 090 137	140 220 090 140	140 220 090 147
Kalınlık	1,27 mm	1,30 mm	1,37 mm	1,40 mm	1,47 mm

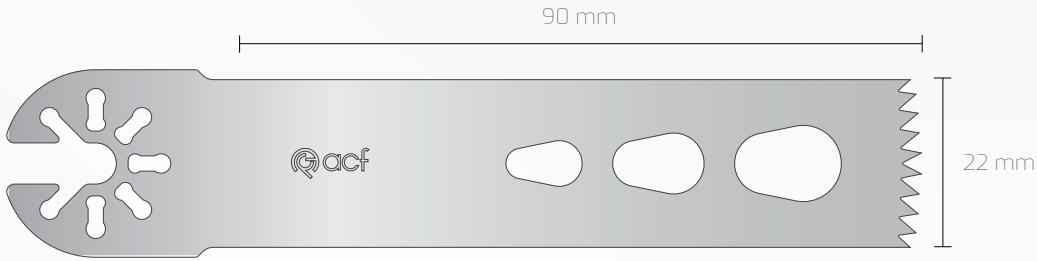

● Non Steril
● Steril R

Ref	140 220 090 150
Kalınlık	1,50 mm

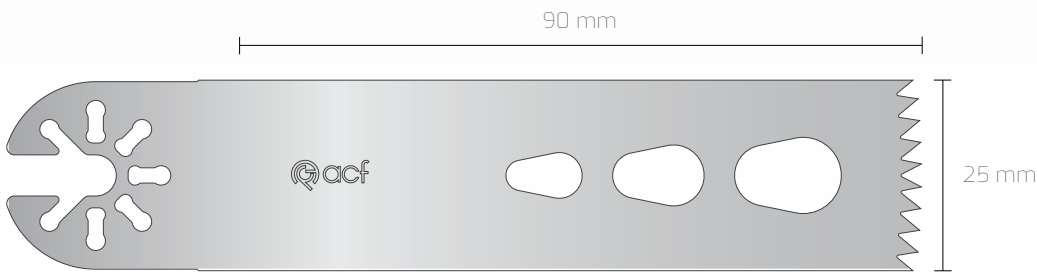

● Non Steril
● Steril R

Ref	140 250 090 089	140 250 090 090	140 250 090 100	140 250 090 119	140 250 090 120
Kalınlık	0,89 mm	0,90 mm	1,00 mm	1,19 mm	1,20 mm

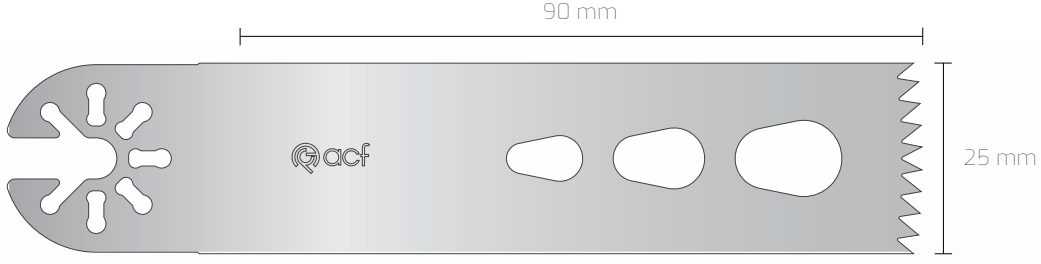

● Non Steril
● Steril R

Ref	140 250 090 127	140 250 090 130	140 250 090 137	140 250 090 140	140 250 090 147
Kalınlık	1,27 mm	1,30 mm	1,37 mm	1,40 mm	1,47 mm

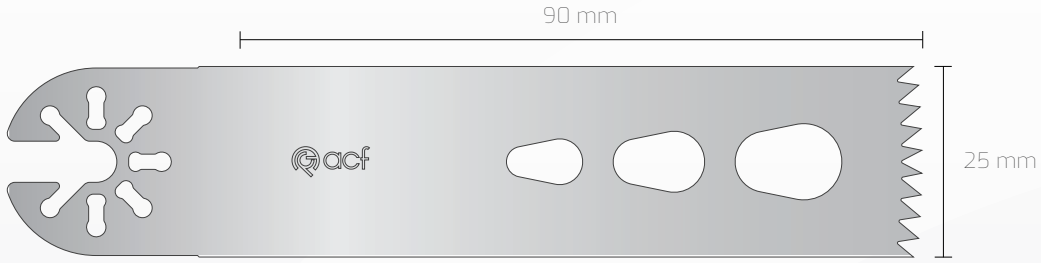

● Non Steril
● Steril R

Ref	140 250 090 150
Kalınlık	1,50 mm

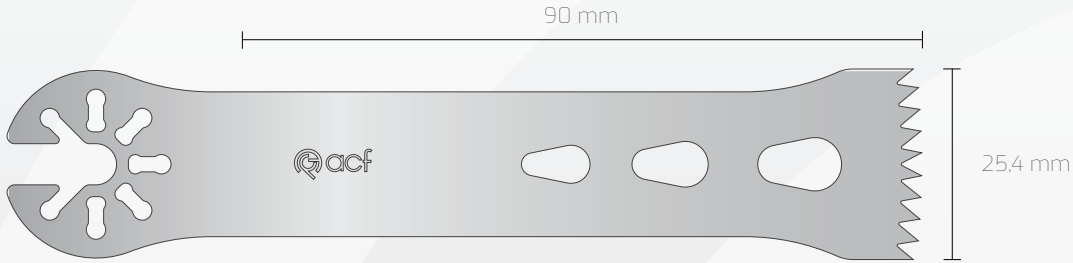

● Non Steril
● Steril R

Ref	140 254 090 089	140 254 090 090	140 254 090 100	140 254 090 119	140 254 090 120
Kalınlık	0,89 mm	0,90 mm	1,00 mm	1,19 mm	1,20 mm

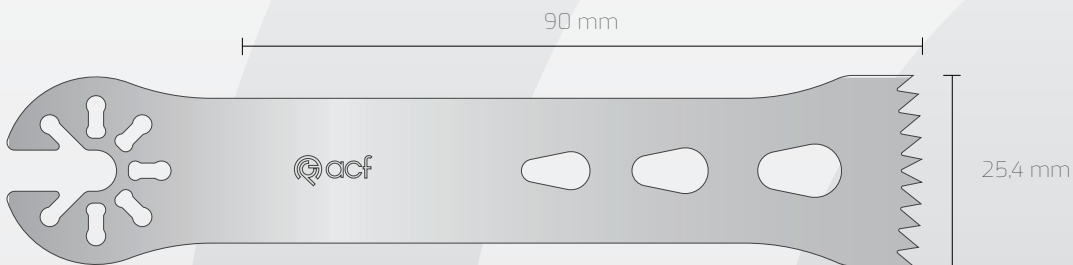

● Non Steril
● Steril R

Ref	140 254 090 127	140 254 090 130	140 254 090 137	140 254 090 140	140 254 090 147
Kalınlık	1,27 mm	1,30 mm	1,37 mm	1,40 mm	1,47 mm

Conmed Linvatec®

Uyumlu Modeller:

M Power PRO6300, M Power2 PRO6350M, PowerPro Max PRO5300M, PowerPro Electric II PRO6125, PowerPro Pneumatic PRO6175, Hall 4 5067-002, Hall 3 5044-002, Versipower Plus 5071-002, Hall 50 PRO7300B

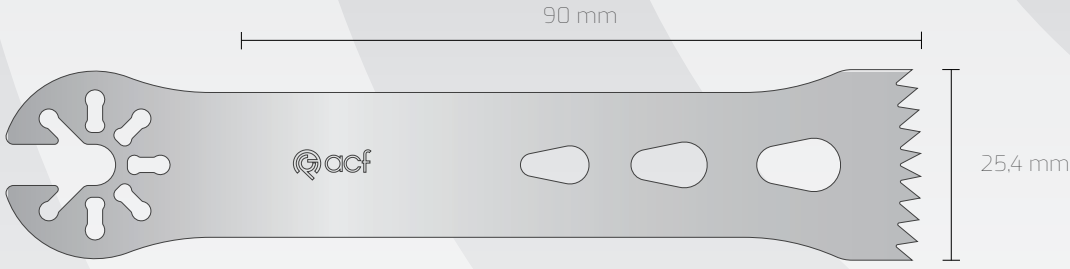

Non Steril

Steril R

Ref 140 254 090 150

Kalınlık 1,50 mm

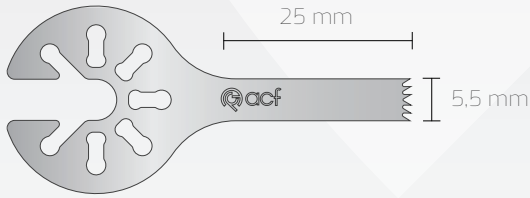

Non Steril

Steril R

Ref 140 055 025 060

Kalınlık 0,60 mm

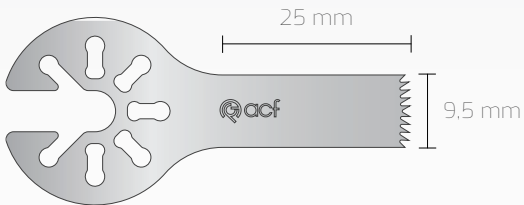

Non Steril

Steril R

Ref 140 095 025 060

Kalınlık 0,60 mm

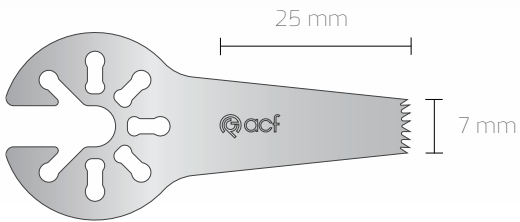

Non Steril

Steril R

Ref 140 070 025 060

Kalınlık 0,60 mm

Tüm testere bıçaklar gerçek ölçülerinde gösterilmiştir. 1:1

CONMED LINVATEC®

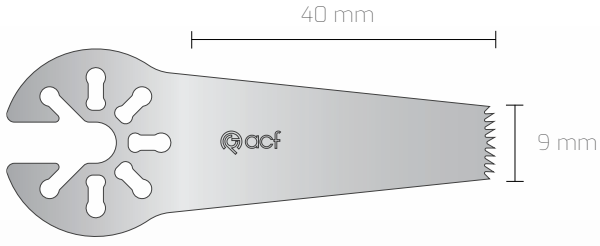

● Non Steril

● Steril R

Ref 140 090 040 060

Kalınlık 0,60 mm

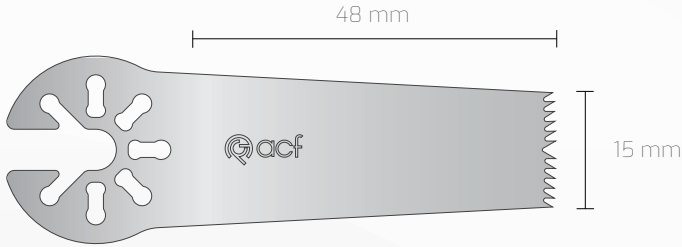

● Non Steril

● Steril R

Ref 140 150 048 060

Kalınlık 0,60 mm

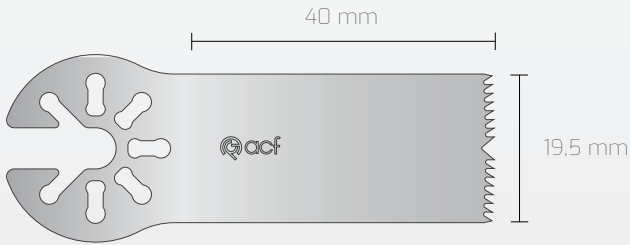

● Non Steril

● Steril R

Ref 140 195 040 060

Kalınlık 0,60 mm

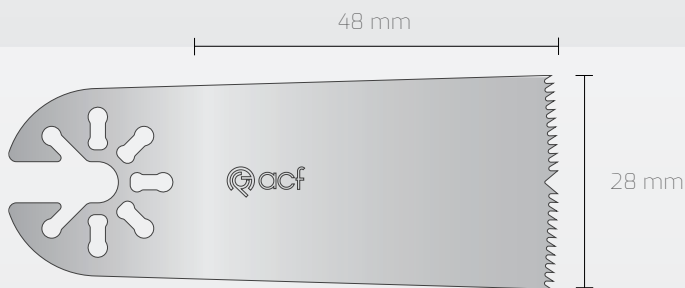

● Non Steril

● Steril R

Ref 140 280 048 060

Kalınlık 0,60 mm

Conmed Linvatec®

Uyumlu Modeller;

M Power PRO6300, M Power2 PRO6350M, PowerPro Max PRO5300M, PowerPro Electric II PRO6125, PowerPro Pneumatic PRO6175, Hall 4 5067-002, Hall 3 5044-002, Versipower Plus 5071-002, Hall 50 PRO7300B

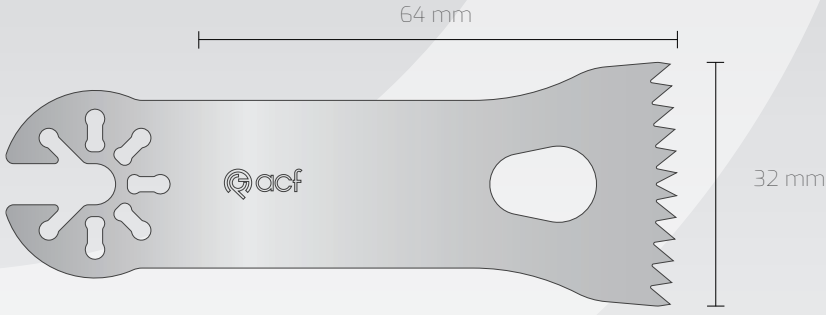

● Non Steril
● Steril R

Ref 140 320 064 090

Kalınlık 0,90 mm

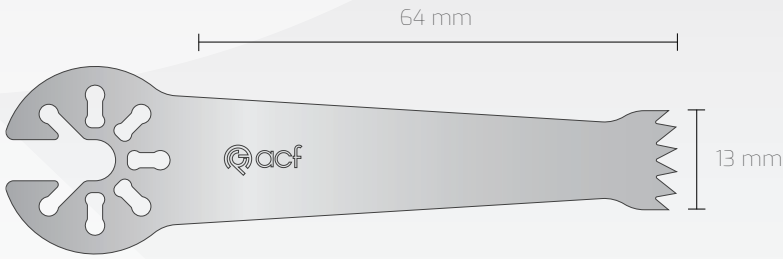

● Non Steril
● Steril R

Ref 140 130 064 090

Kalınlık 0,90 mm

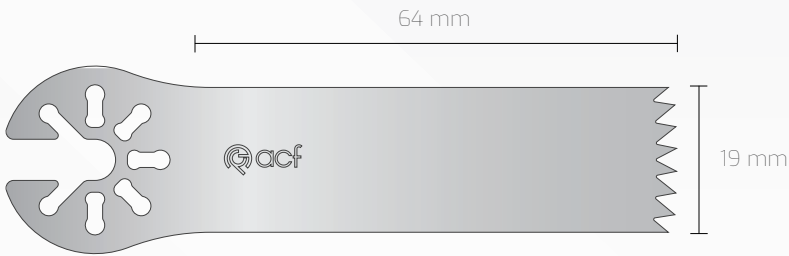

● Non Steril
● Steril R

Ref 140 190 064 090

Kalınlık 0,90 mm

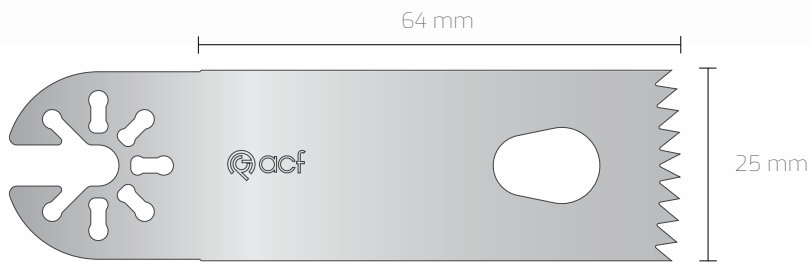

● Non Steril
● Steril R

Ref 140 250 064 090

Kalınlık 0,90 mm

CONMED LINVATEC®

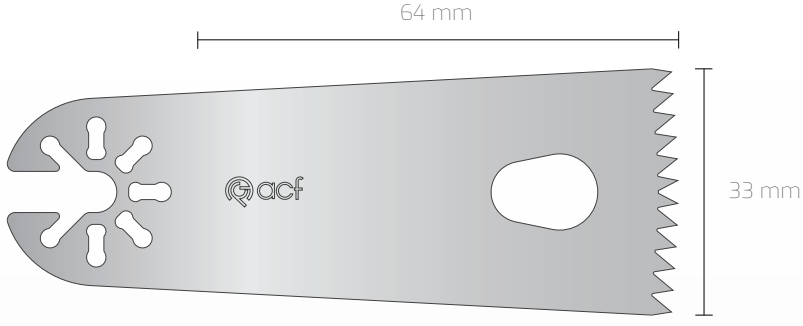

● Non Steril
● Steril R

Ref 140 330 064 090

Kalınlık 0,90 mm

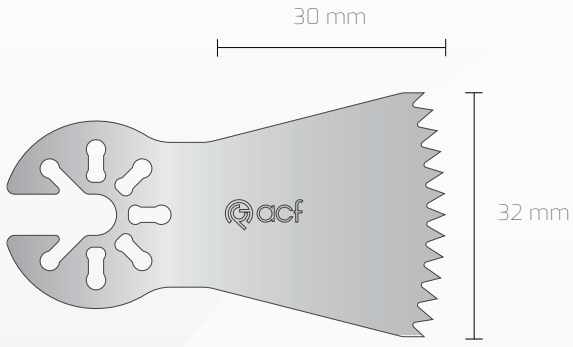

● Non Steril
● Steril R

Ref 140 320 030 090

Kalınlık 0,90 mm

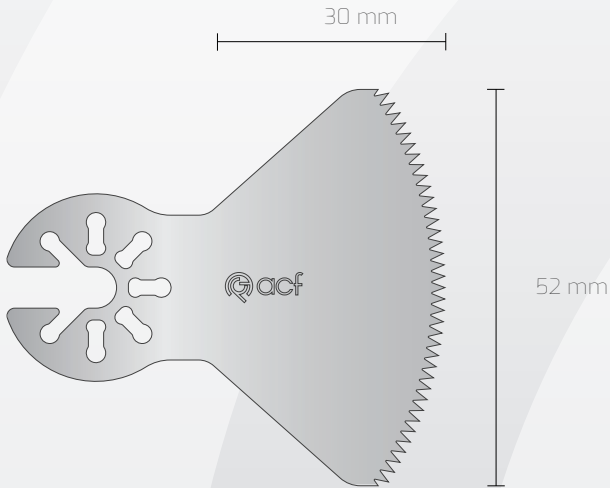

● Non Steril
● Steril R

Ref 140 520 030 090

Kalınlık 0,90 mm

Conmed Linvatec®

Uyumlu Modeller:

M Power PRO6300, M Power2 PRO6350M, PowerPro Max PRO5300M, PowerPro Electric II PRO6125, PowerPro Pneumatic PRO6175, Hall 4 5067-002, Hall 3 5044-002, Versipower Plus 5071-002, Hall 50 PRO7300B

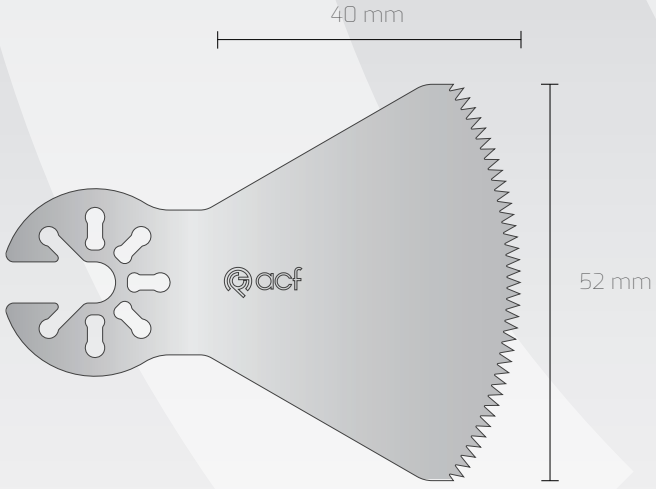

● Non Steril

● Steril R

Ref 140 520 040 090

Kalınlık 0,90 mm

CONMED LINVATEC®

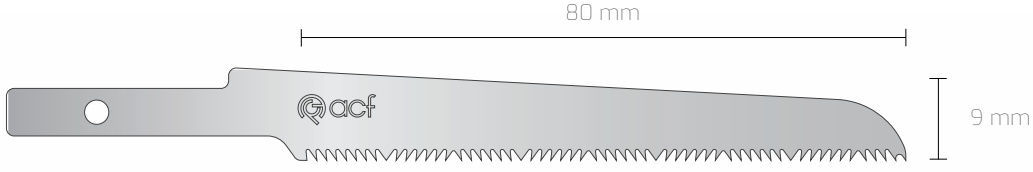

● Non Steril
● Steril R

Ref 100 090 080 060
Kalınlık 0,60 mm

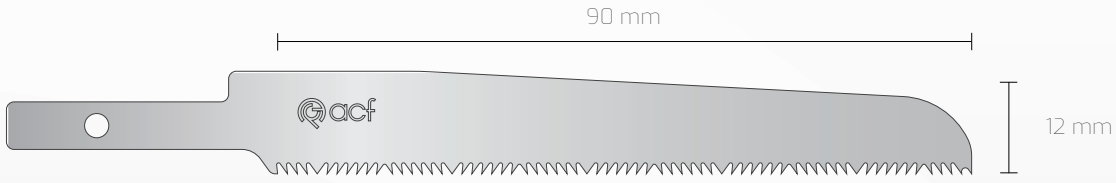

● Non Steril
● Steril R

Ref 100 120 090 060 100 120 090 090
Kalınlık 0,60 mm 0,90 mm

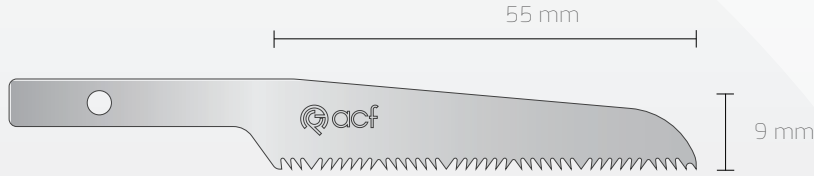

● Non Steril
● Steril R

Ref 100 090 055 060 100 090 055 090
Kalınlık 0,60 mm 0,90 mm

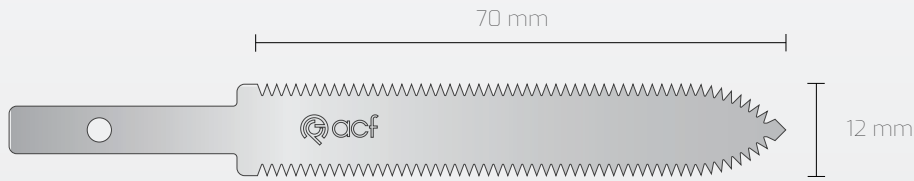

● Non Steril
● Steril R

Ref 100 120 070 060 100 120 070 090 100 120 070 100 100 120 070 120
Kalınlık 0,60 mm 0,90 mm 1,00 mm 1,20 mm

Conmed Linvatec®

Uyumlu Modeller;

PowerPro Pneumatic PRO6185, PowerPro Electric II PRO6135,
PowerPro Max PRO5400M, MPower 2 PRO6400M, MPower PRO6400,
Hall 4 5067-003, Hall 50 PRO7400B reciprocating saws

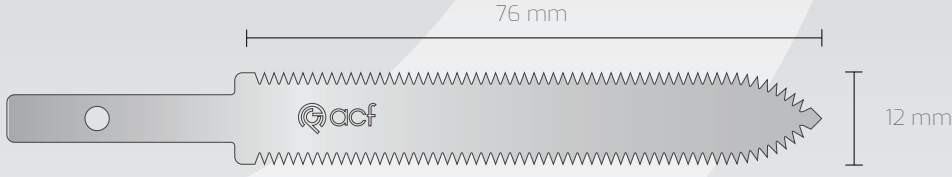

● Non Steril
● Steril R

Ref	100 120 076 060	100 120 076 090	100 120 076 100	100 120 076 120
Kalınlık	0,60 mm	0,90 mm	1,00 mm	1,20 mm

CONMED LINVATEC®

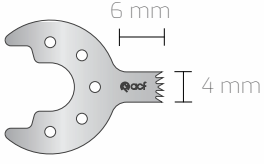

● Non Steril
● Steril R

Ref 100 040 006 060
Kalınlık 0,60 mm



● Non Steril
● Steril R

Ref 100 045 026 060
Kalınlık 0,60 mm

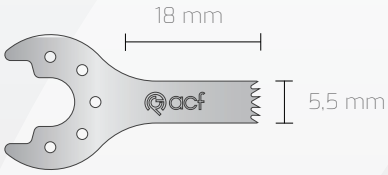

● Non Steril
● Steril R

Ref 100 055 018 060
Kalınlık 0,60 mm



● Non Steril
● Steril R

Ref 100 055 026 060
Kalınlık 0,60 mm

Conmed Linvatec®

Uyumlu Modeller:

Micro 100™ 5053-011, Micro Power™ 6020-022,
Micro Power™ 6021-022 Sagittal Saws,
MicroChoice, 5040-002, Micro E 5020-022

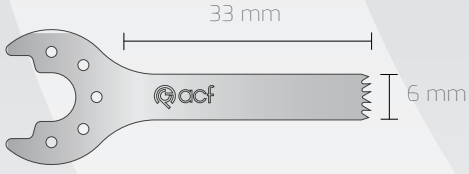

● Non Steril
● Steril R

Ref 100 060 033 060

Kalınlık 0,60 mm

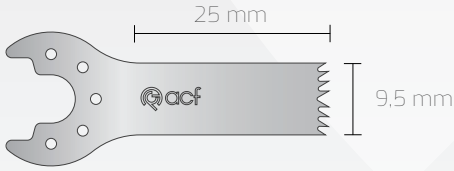

● Non Steril
● Steril R

Ref 100 095 025 060

Kalınlık 0,60 mm

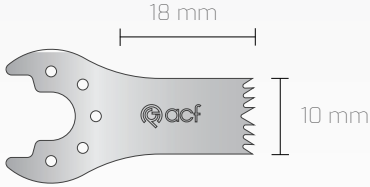

● Non Steril
● Steril R

Ref 100 100 018 060

Kalınlık 0,60 mm

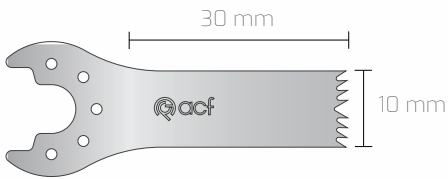

● Non Steril
● Steril R

Ref 100 100 030 060

Kalınlık 0,60 mm

CONMED LINVATEC®

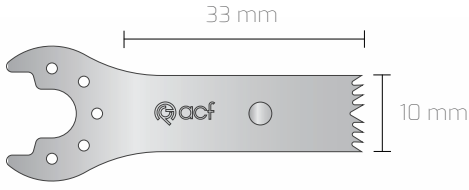

● Non Steril

● Steril R

Ref 100 100 033 060

Kalınlık 0,60 mm

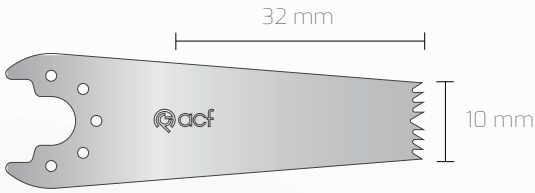

● Non Steril

● Steril R

Ref 100 100 032 060

Kalınlık 0,60 mm

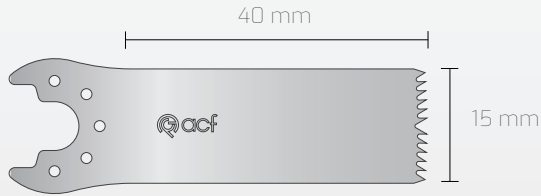

● Non Steril

● Steril R

Ref 100 150 040 060

Kalınlık 0,60 mm



DE SOUTTER[®]
ile Uyumlu
Testere Bıçaklar



Marka Kodu **200**

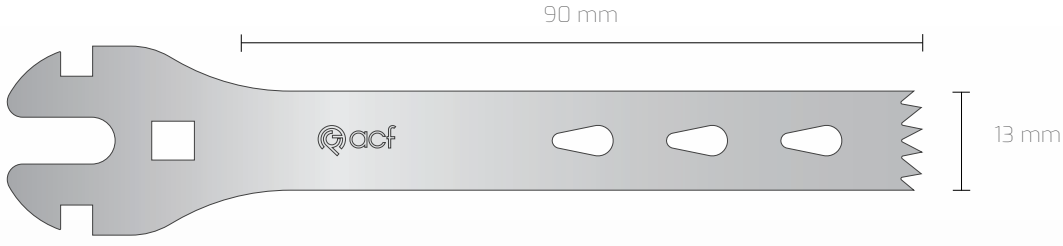

● Non Steril
 ● Steril R

Ref	200 130 090 089	200 130 090 090	200 130 090 100	200 130 090 119	200 130 090 120
Kalınlık	0,89 mm	0,90 mm	1,00 mm	1,19 mm	1,20 mm

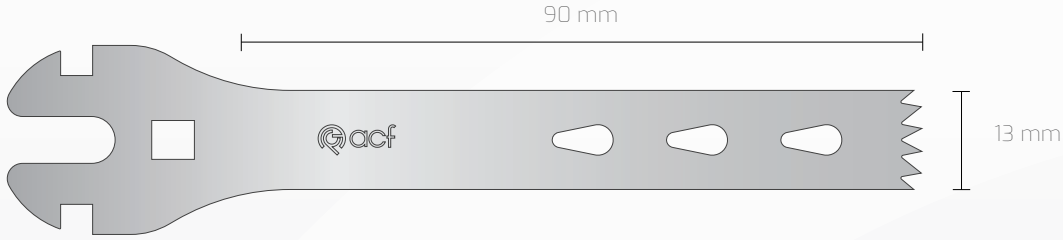

● Non Steril
 ● Steril R

Ref	200 130 090 127	200 130 090 130	200 130 090 137	200 130 090 140	200 130 090 147
Kalınlık	1,27 mm	1,30 mm	1,37 mm	1,40 mm	1,47 mm

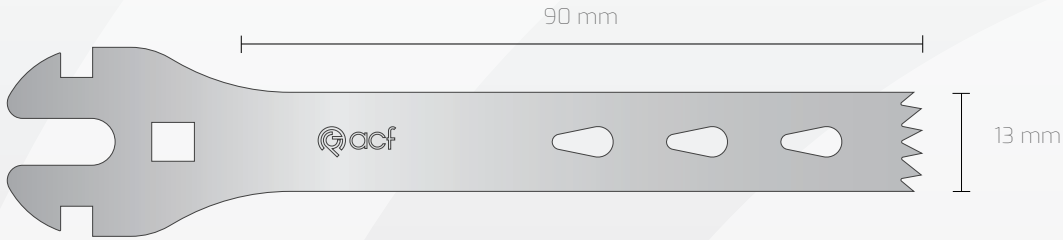

● Non Steril
 ● Steril R

Ref	200 130 090 150
Kalınlık	1,50 mm

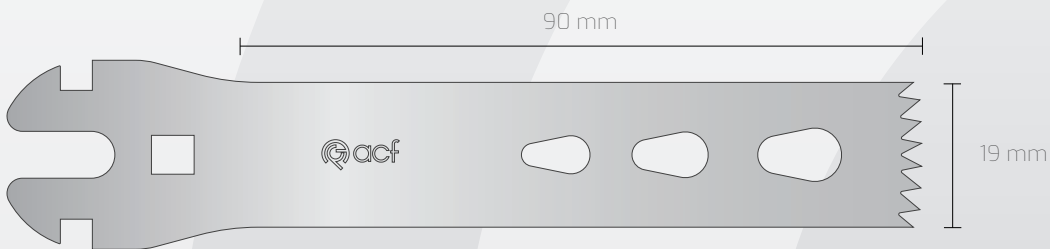

● Non Steril
 ● Steril R

Ref	200 190 090 089	200 190 090 090	200 190 090 100	200 190 090 119	200 190 090 120
Kalınlık	0,89 mm	0,90 mm	1,00 mm	1,19 mm	1,20 mm

De Soutter®

Uyumlu Modeller;

MDX Multi Drive KX 600, MDX Multi Drive KDX-600,
MPX Multi Drive SX 500, MPX Multi Drive DPX-676,
MCX Multi Drive DCX 500, Orthodrive DBK-700

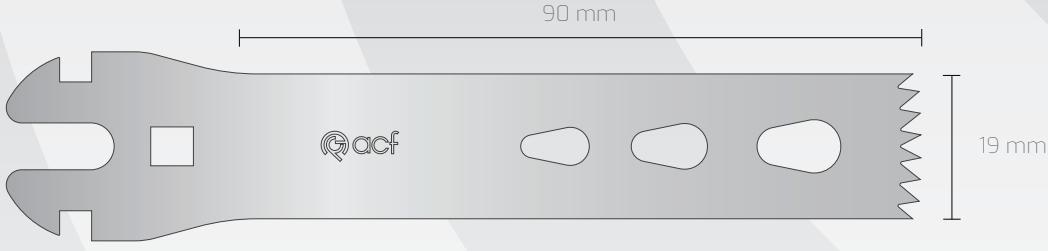

● Non Steril
● Steril R

Ref	200 190 090 127	200 190 090 130	200 190 090 137	200 190 090 140	200 190 090 147
Kalınlık	1,27 mm	1,30 mm	1,37 mm	1,40 mm	1,47 mm

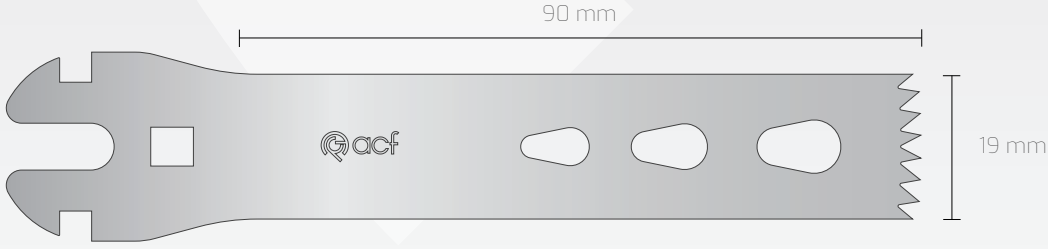

● Non Steril
● Steril R

Ref	200 190 090 150
Kalınlık	1,50 mm

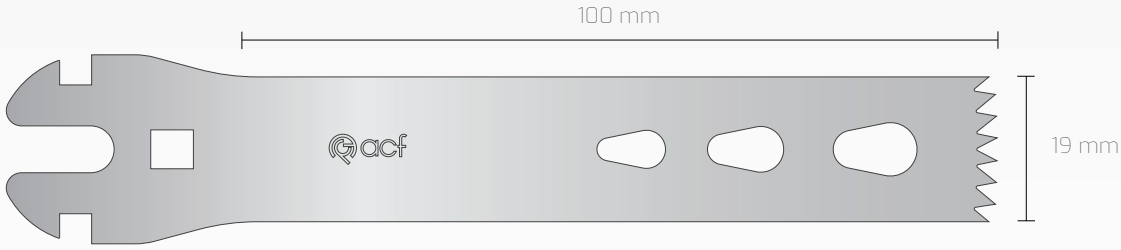

● Non Steril
● Steril R

Ref	200 190 100 089	200 190 100 090	200 190 100 100	200 190 100 119	200 190 100 120
Kalınlık	0,89 mm	0,90 mm	1,00 mm	1,19 mm	1,20 mm

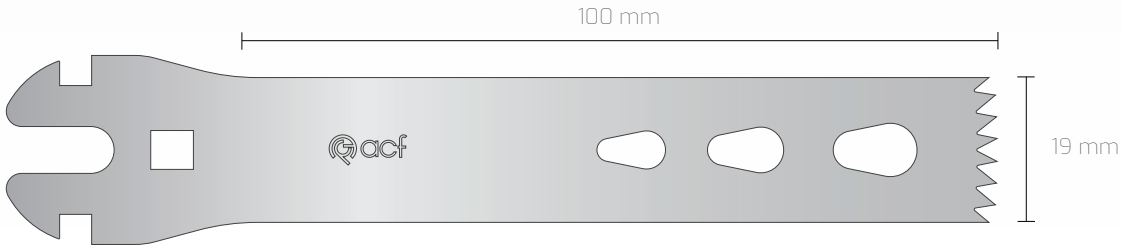

● Non Steril
● Steril R

Ref	200 190 100 127	200 190 100 130	200 190 100 137	200 190 100 140	200 190 100 147
Kalınlık	1,27 mm	1,30 mm	1,37 mm	1,40 mm	1,47 mm

Tüm testere bıçaklar gerçek ölçülerinde gösterilmiştir. 1:1

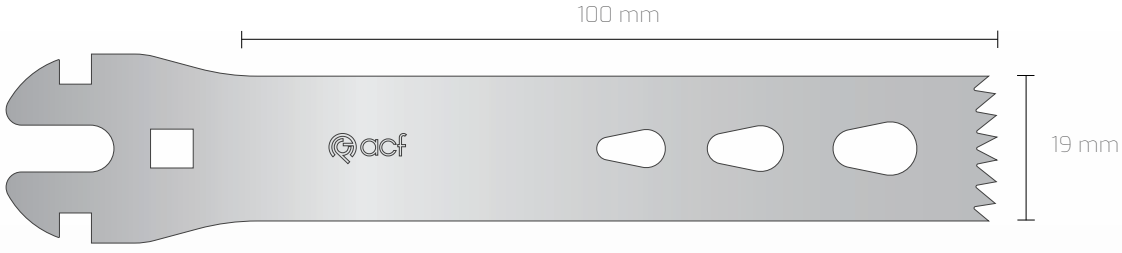

● Non Steril
 ● Steril R

Ref **200 190 100 150**
 Kalınlık 1,50 mm

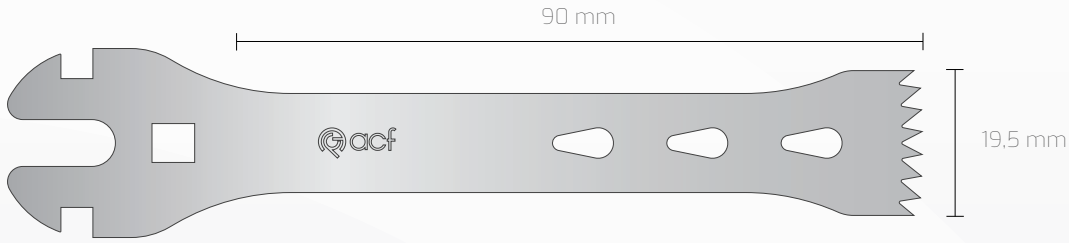

● Non Steril
 ● Steril R

Ref	200 195 090 089	200 195 090 090	200 195 090 100	200 195 090 119	200 195 090 120
Kalınlık	0,89 mm	0,90 mm	1,00 mm	1,19 mm	1,20 mm

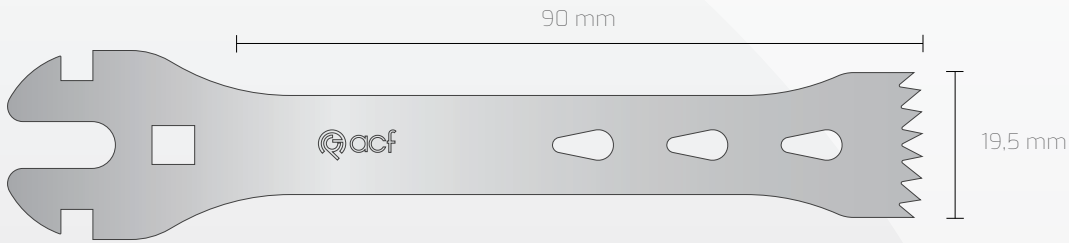

● Non Steril
 ● Steril R

Ref	200 195 090 127	200 195 090 130	200 195 090 137	200 195 090 140	200 195 090 147
Kalınlık	1,27 mm	1,30 mm	1,37 mm	1,40 mm	1,47 mm

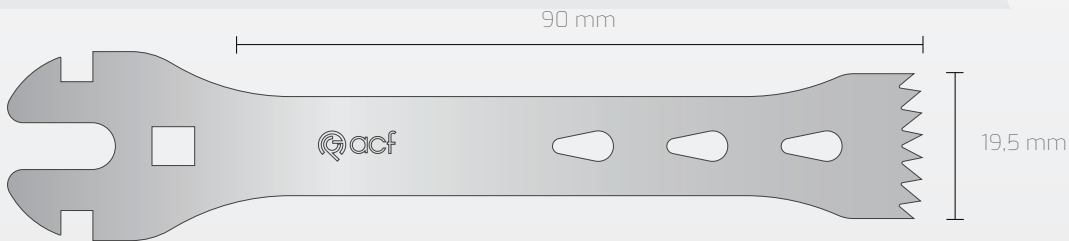

● Non Steril
 ● Steril R

Ref **200 195 090 150**
 Kalınlık 1,50 mm

Uyumlu Modeller;

MDX Multi Drive KX 600, MDX Multi Drive KDX-600,
MPX Multi Drive SX 500, MPX Multi Drive DPX-676,
MCX Multi Drive DCX 500, Orthodrive DBK-700

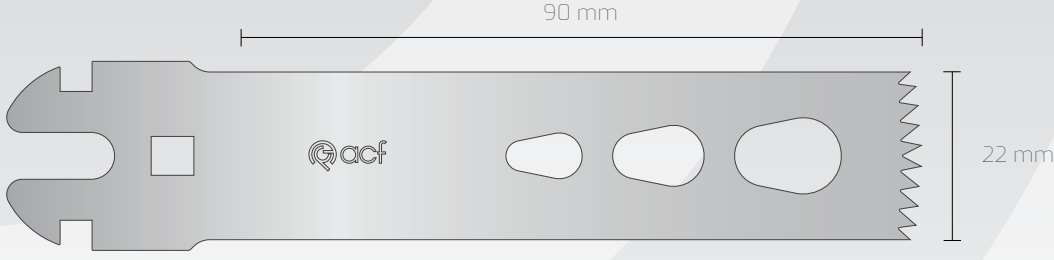

● Non Steril
● Steril R

Ref	200 220 090 089	200 220 090 090	200 220 090 100	200 220 090 119	200 220 090 120
Kalınlık	0,89 mm	0,90 mm	1,00 mm	1,19 mm	1,20 mm

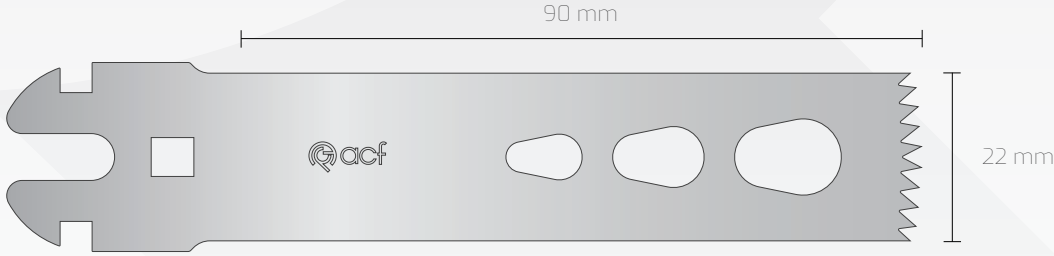

● Non Steril
● Steril R

Ref	200 220 090 127	200 220 090 130	200 220 090 137	200 220 090 140	200 220 090 147
Kalınlık	1,27 mm	1,30 mm	1,37 mm	1,40 mm	1,47 mm

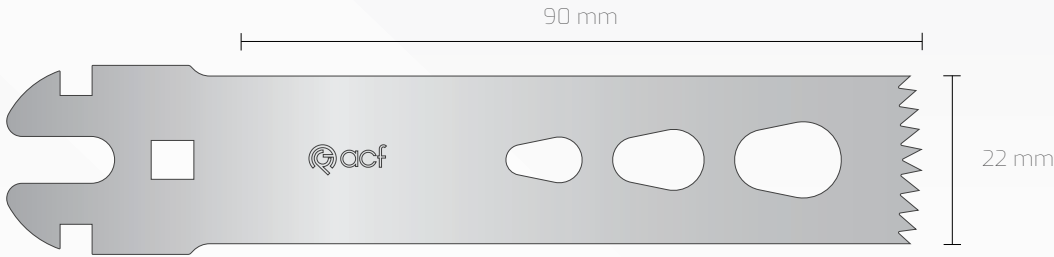

● Non Steril
● Steril R

Ref	200 220 090 150
Kalınlık	1,50 mm

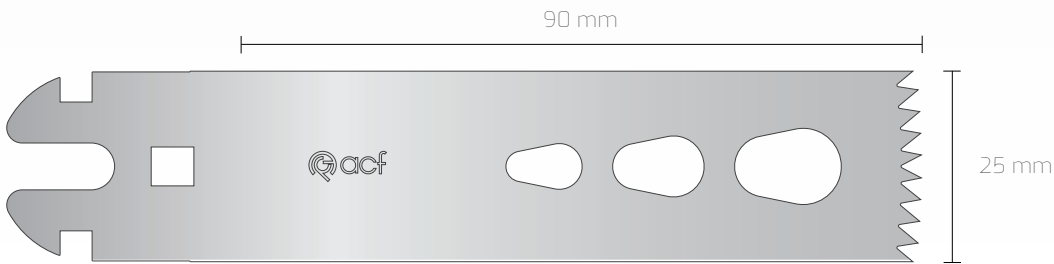

● Non Steril
● Steril R

Ref	200 250 090 089	200 250 090 090	200 250 090 100	200 250 090 119	200 250 090 120
Kalınlık	0,89 mm	0,90 mm	1,00 mm	1,19 mm	1,20 mm

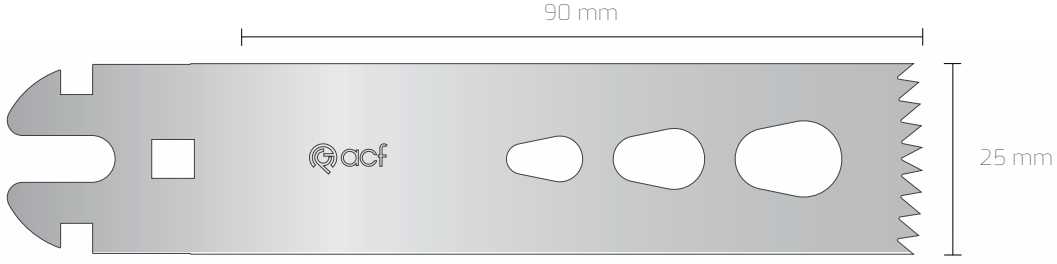

● Non Steril
 ● Steril R

Ref	200 250 090 127	200 250 090 130	200 250 090 137	200 250 090 140	200 250 090 147
Kalınlık	1,27 mm	1,30 mm	1,37 mm	1,40 mm	1,47 mm

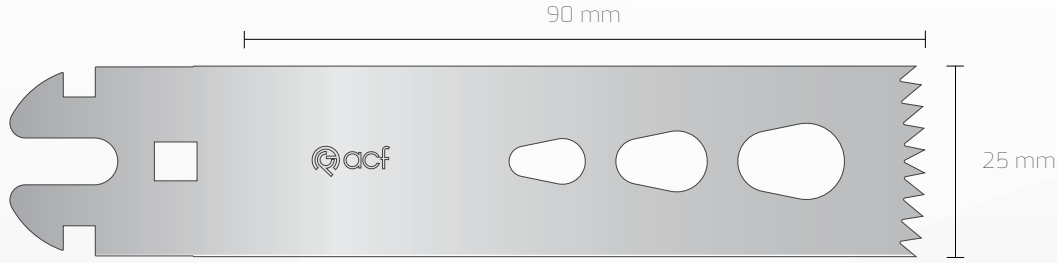

● Non Steril
 ● Steril R

Ref	200 250 090 150
Kalınlık	1,50 mm

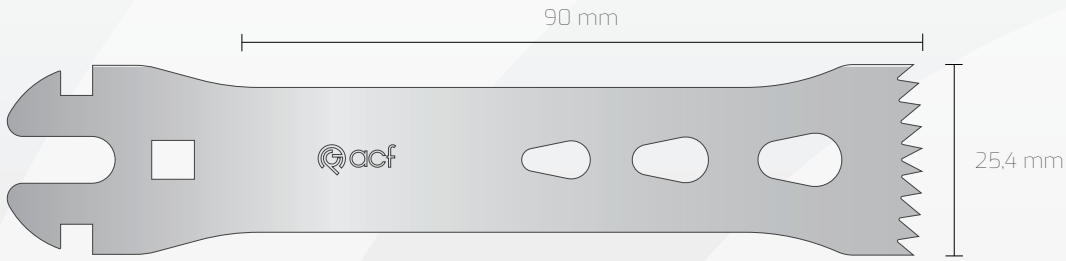

● Non Steril
 ● Steril R

Ref	200 254 090 089	200 254 090 090	200 254 090 100	200 254 090 119	200 254 090 120
Kalınlık	0,89 mm	0,90 mm	1,00 mm	1,19 mm	1,20 mm

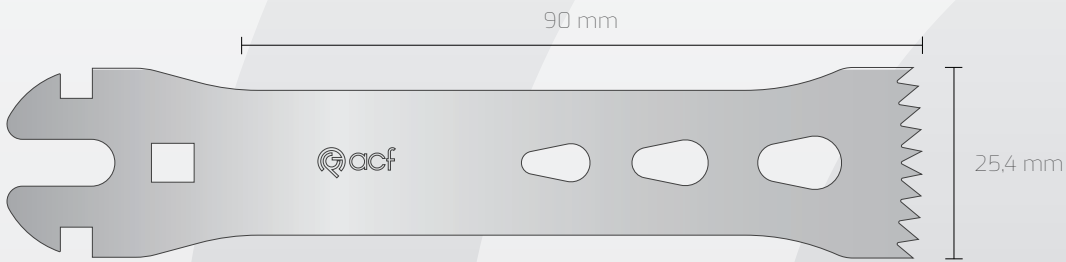

● Non Steril
 ● Steril R

Ref	200 254 090 127	200 254 090 130	200 254 090 137	200 254 090 140	200 254 090 147
Kalınlık	1,27 mm	1,30 mm	1,37 mm	1,40 mm	1,47 mm

De Soutter®

Uyumlu Modeller;

MDX Multi Drive KX 600, MDX Multi Drive KDX-600,
MPX Multi Drive SX 500, MPX Multi Drive DPX-676,
MCX Multi Drive DCX 500, Orthodrive DBK-700

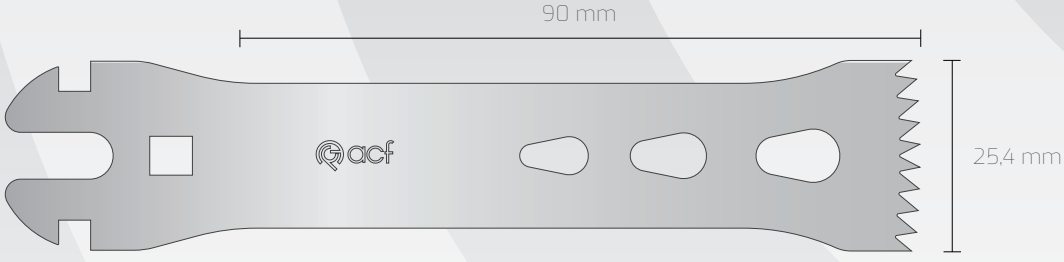

● Non Steril

● Steril R

Ref 200 254 090 150

Kalınlık 1,50 mm

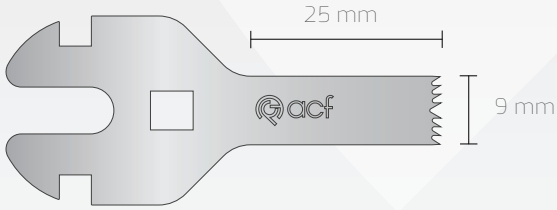

● Non Steril

● Steril R

Ref 200 090 025 060

Kalınlık 0,60 mm

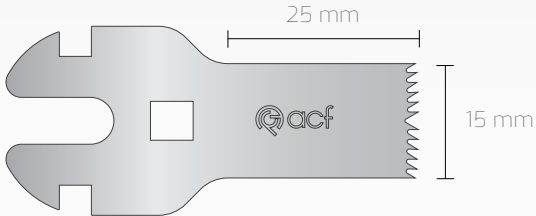

● Non Steril

● Steril R

Ref 200 150 025 060

Kalınlık 0,60 mm

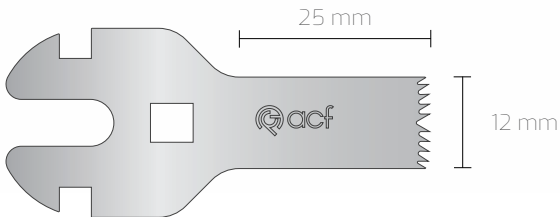

● Non Steril

● Steril R

Ref 200 120 025 060

Kalınlık 0,60 mm

Tüm testere bıçaklar gerçek ölçülerinde gösterilmiştir. 1:1

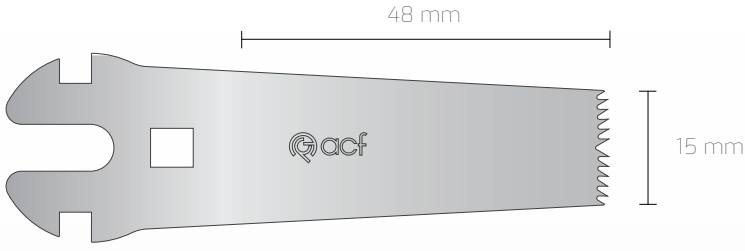

● Non Steril
● Steril R

Ref **200 150 048 060**

Kalınlık 0,60 mm

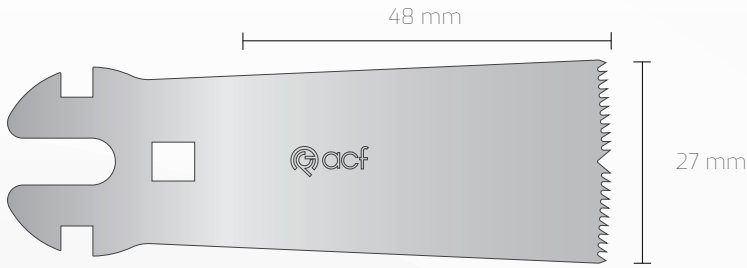

● Non Steril
● Steril R

Ref **200 270 048 060**

Kalınlık 0,60 mm

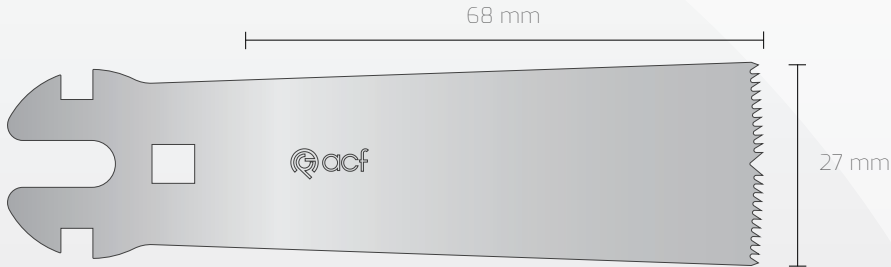

● Non Steril
● Steril R

Ref **200 270 068 060**

Kalınlık 0,60 mm

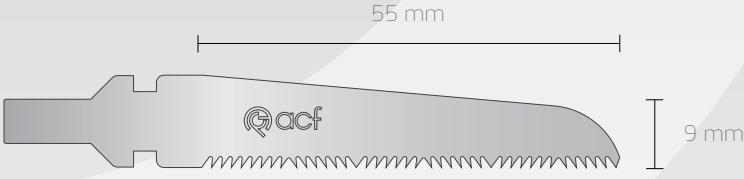

● Non Steril
● Steril R

Ref	200 090 055 060	200 090 055 090
Kalınlık	0,60 mm	0,90 mm

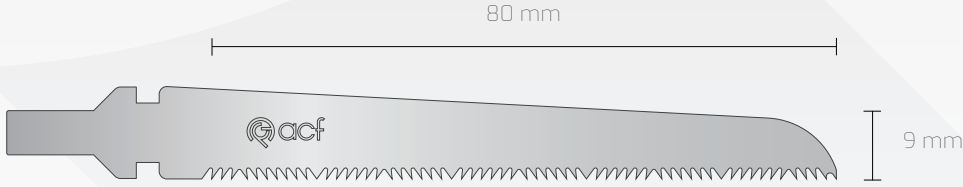

● Non Steril
● Steril R

Ref	200 090 080 060	200 090 080 090	200 090 080 100
Kalınlık	0,60 mm	0,90 mm	1,00 mm

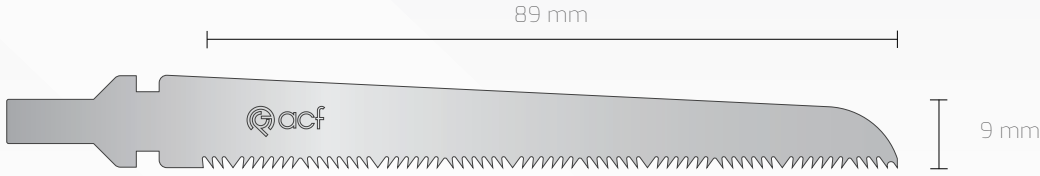

● Non Steril
● Steril R

Ref	200 090 089 100	200 090 089 120	200 090 089 130
Kalınlık	1,00 mm	1,20 mm	1,30 mm



● Non Steril
● Steril R

Ref	200 100 089 120	200 100 089 130
Kalınlık	1,20 mm	1,30 mm

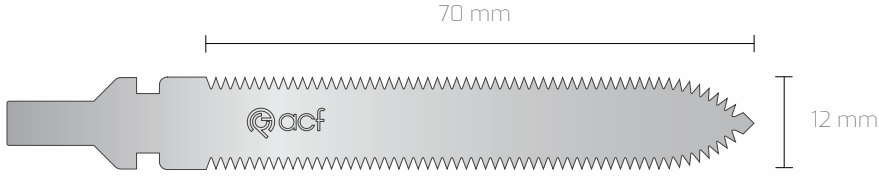

● Non Steril
● Steril R

Ref 200 120 070 100
Kalınlık 1,00 mm

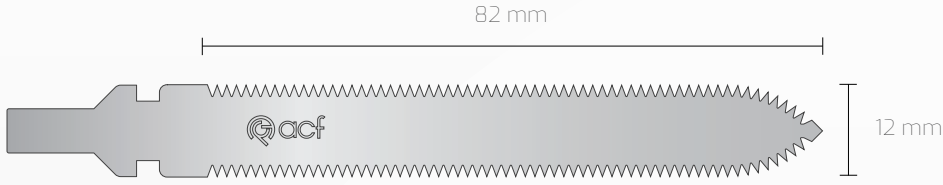

● Non Steril
● Steril R

Ref 200 120 082 120
Kalınlık 1,20 mm

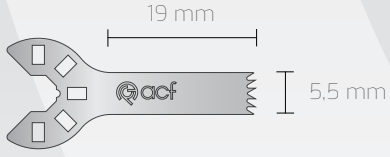

Non Steril

Steril R

Ref 200 055 019 060

Kalınlık 0,60 mm

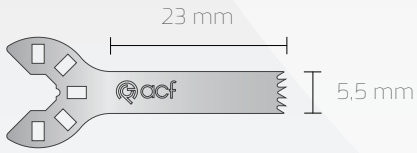

Non Steril

Steril R

Ref 200 055 023 060

Kalınlık 0,60 mm

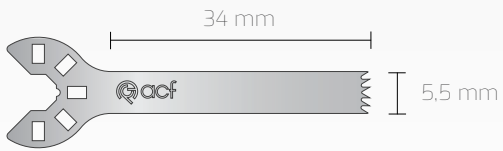

Non Steril

Steril R

Ref 200 055 034 060

Kalınlık 0,60 mm

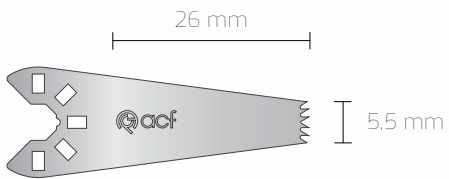

Non Steril

Steril R

Ref 200 055 026 060

Kalınlık 0,60 mm

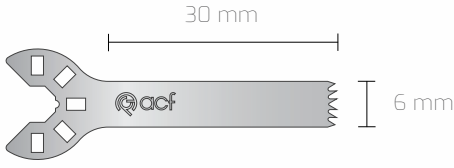

● Non Steril
● Steril R

Ref 200 060 030 060

Kalınlık 0,60 mm

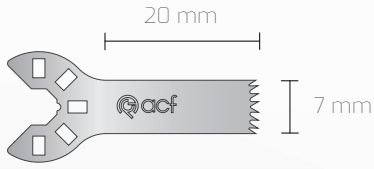

● Non Steril
● Steril R

Ref 200 070 020 060

Kalınlık 0,60 mm

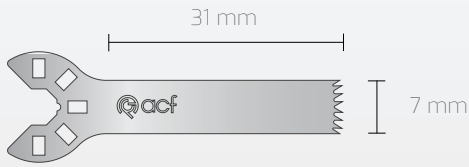

● Non Steril
● Steril R

Ref 200 070 031 060

Kalınlık 0,60 mm

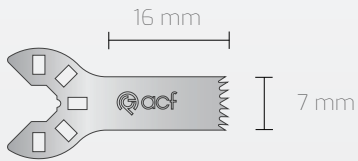

● Non Steril
● Steril R

Ref 200 070 016 060

Kalınlık 0,60 mm

De Soutter®

Uyumlu Modeller;

SU-471/2

5I-270

0I-270

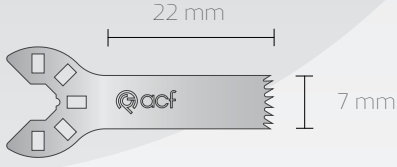

● Non Steril
● Steril R

Ref 200 070 022 060

Kalınlık 0,60 mm

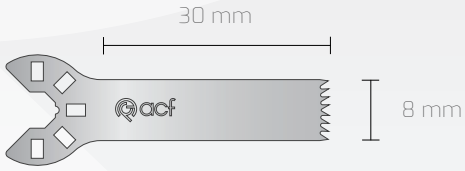

● Non Steril
● Steril R

Ref 200 080 030 060

Kalınlık 0,60 mm

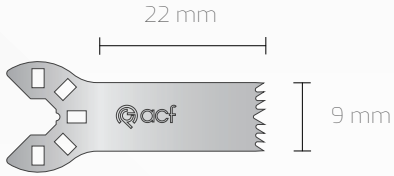

● Non Steril
● Steril R

Ref 200 090 022 060

Kalınlık 0,60 mm

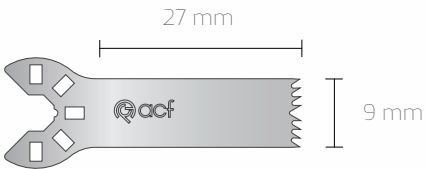

● Non Steril
● Steril R

Ref 200 090 027 060

Kalınlık 0,60 mm

Tüm testere bıçaklar gerçek ölçülerinde gösterilmiştir. 1:1

DE SOUTTER®

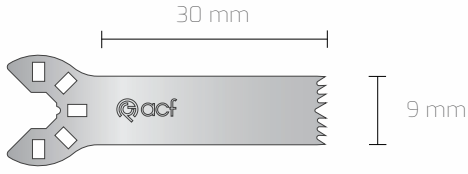
●
Non Steril●
Steril R**Ref** 200 090 030 060

Kalınlık 0,60 mm

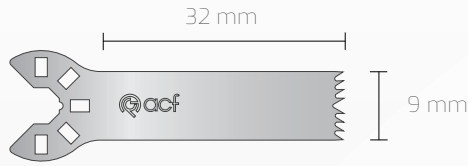
●
Non Steril●
Steril R**Ref** 200 090 032 060

Kalınlık 0,60 mm

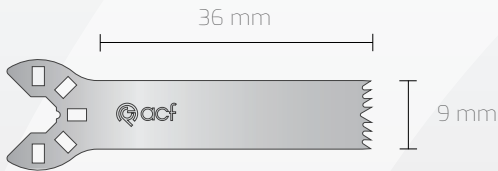
●
Non Steril●
Steril R**Ref** 200 090 036 060

Kalınlık 0,60 mm

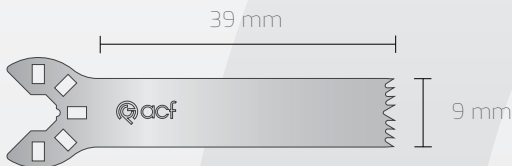
●
Non Steril●
Steril R**Ref** 200 090 039 060

Kalınlık 0,60 mm

De Soutter®

Uyumlu Modeller;

SU-471/2

SI-270

OI-270

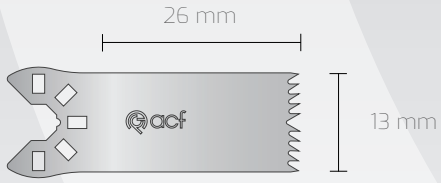

Non Steril

Steril R

Ref 200 130 026 060

Kalınlık 0,60 mm

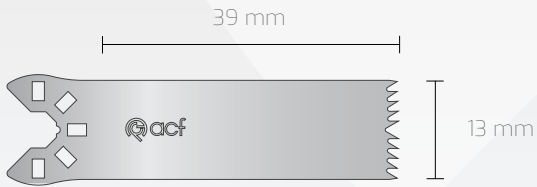

Non Steril

Steril R

Ref 200 130 039 060

Kalınlık 0,60 mm

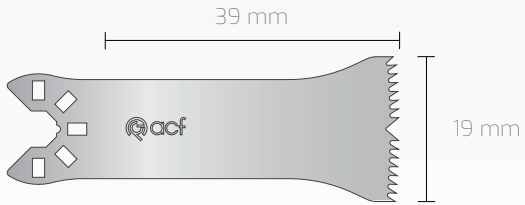

Non Steril

Steril R

Ref 200 190 039 060

Kalınlık 0,60 mm



SMITH & NEPHEW DYONICS®
ile Uyumlu
Testere Bıçaklar



Marka Kodu **210**

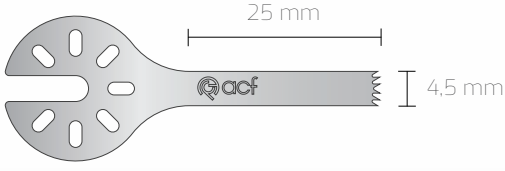

● Non Steril
● Steril R

Ref 210 045 025 060
Kalınlık 0,60 mm



● Non Steril
● Steril R

Ref 210 050 026 060
Kalınlık 0,60 mm



● Non Steril
● Steril R

Ref 210 058 018 060
Kalınlık 0,60 mm



● Non Steril
● Steril R

Ref 210 058 025 060
Kalınlık 0,60 mm

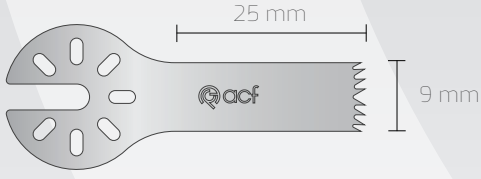

Non Steril
Steril R

Ref 210 090 025 060

Kalınlık 0,60 mm

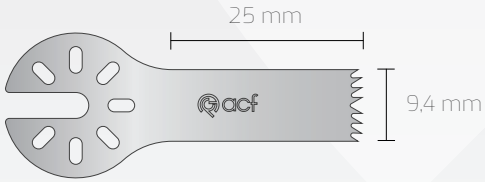

Non Steril
Steril R

Ref 210 094 025 060

Kalınlık 0,60 mm

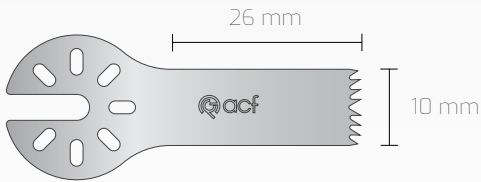

Non Steril
Steril R

Ref 210 100 026 060

Kalınlık 0,60 mm

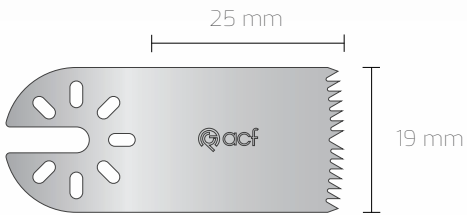

Non Steril
Steril R

Ref 210 190 025 060

Kalınlık 0,60 mm



DEPUY SYNTHES®
ile Uyumlu
Testere Bıçaklar



Marka Kodu **220**

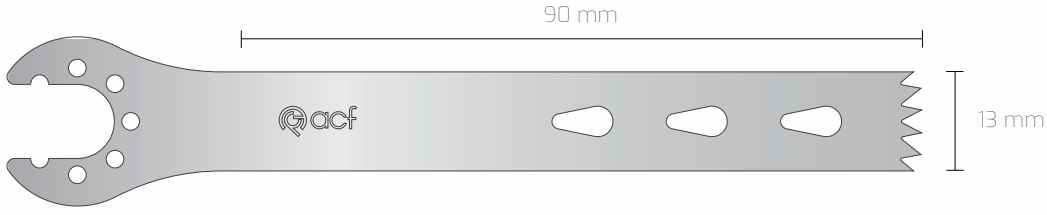

● Non Steril
● Steril R

Ref	220 130 090 089	220 130 090 090	220 130 090 100	220 130 090 119	220 130 090 120
Kalınlık	0,89 mm	0,90 mm	1,00 mm	1,19 mm	1,20 mm

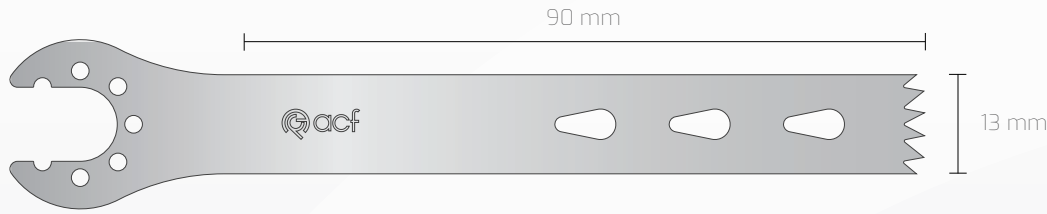

● Non Steril
● Steril R

Ref	220 130 090 127	220 130 090 130	220 130 090 137	220 130 090 140	220 130 090 147
Kalınlık	1,27 mm	1,30 mm	1,37 mm	1,40 mm	1,47 mm

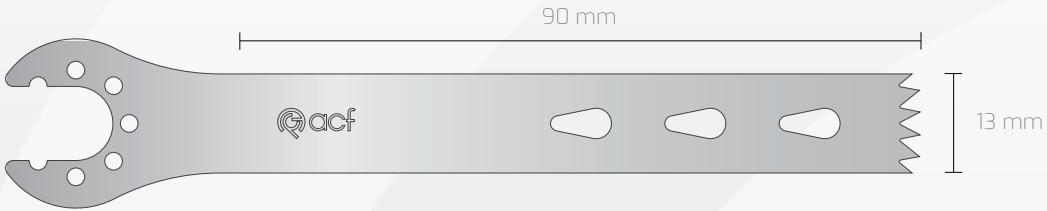

● Non Steril
● Steril R

Ref	220 130 090 150
Kalınlık	1,50 mm

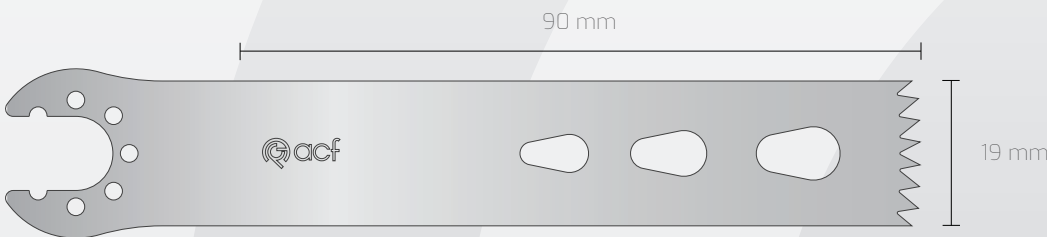

● Non Steril
● Steril R

Ref	220 190 090 089	220 190 090 090	220 190 090 100	220 190 090 119	220 190 090 120
Kalınlık	0,89 mm	0,90 mm	1,00 mm	1,19 mm	1,20 mm

Depuy Synthes®

Uyumlu Modeller;

Compact AirDrive II + Power Drive 511.800, 511.801, Air Power Line 511.610, Battery Power Line 530.610, TRS 05.001.224, 05.001.223, 05.001.240, Battery Power Line II 530.710

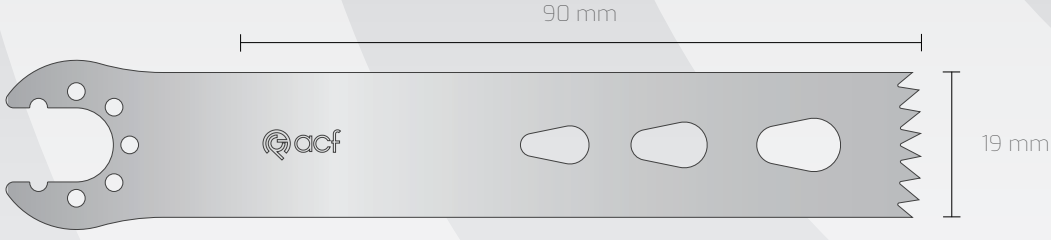

● Non Steril
● Steril R

Ref	220 190 090 127	220 190 090 130	220 190 090 137	220 190 090 140	220 190 090 147
Kalınlık	1,27 mm	1,30 mm	1,37 mm	1,40 mm	1,47 mm

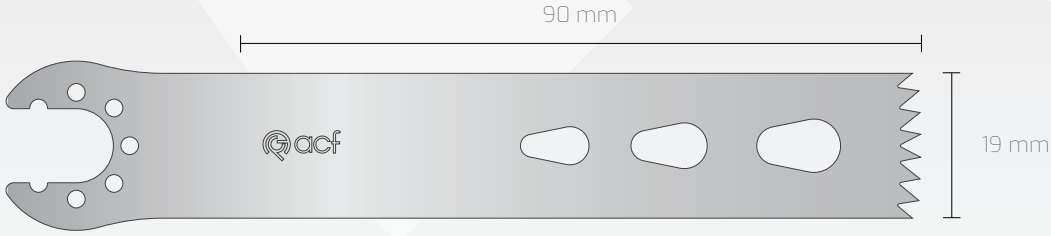

● Non Steril
● Steril R

Ref	220 190 090 150
Kalınlık	1,50 mm

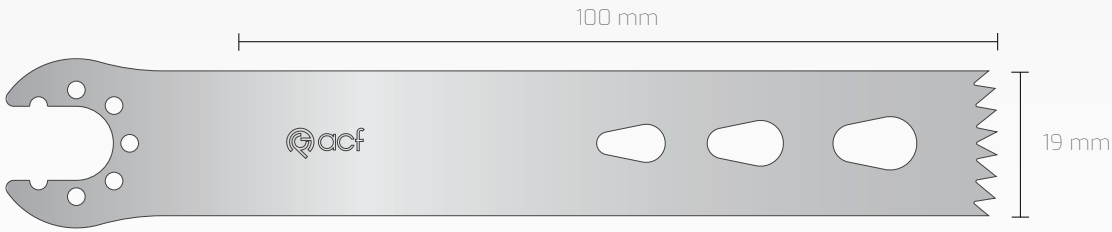

● Non Steril
● Steril R

Ref	220 190 100 089	220 190 100 090	220 190 100 100	220 190 100 119	220 190 100 120
Kalınlık	0,89 mm	0,90 mm	1,00 mm	1,19 mm	1,20 mm

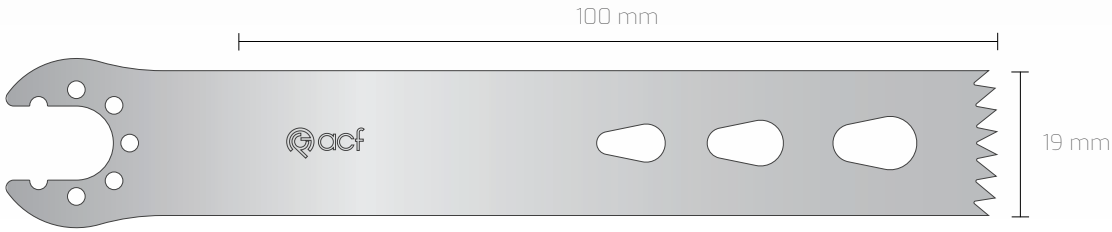

● Non Steril
● Steril R

Ref	220 190 100 127	220 190 100 130	220 190 100 137	220 190 100 140	220 190 100 147
Kalınlık	1,27 mm	1,30 mm	1,37 mm	1,40 mm	1,47 mm

Tüm testere bıçaklar gerçek ölçülerinde gösterilmiştir. 1:1

● Non Steril
 ● Steril R

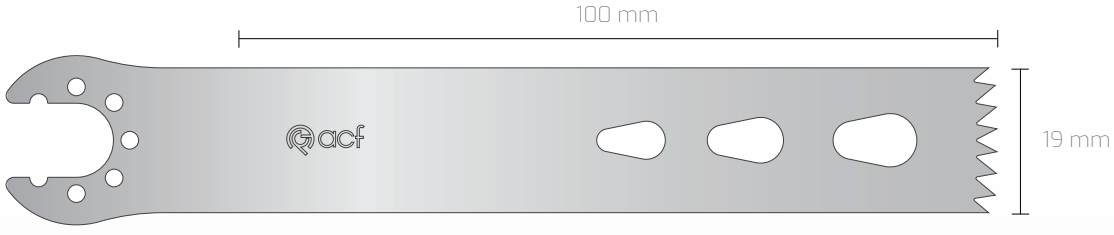

Ref 220 190 100 150
Kalınlık 1,50 mm

● Non Steril
 ● Steril R

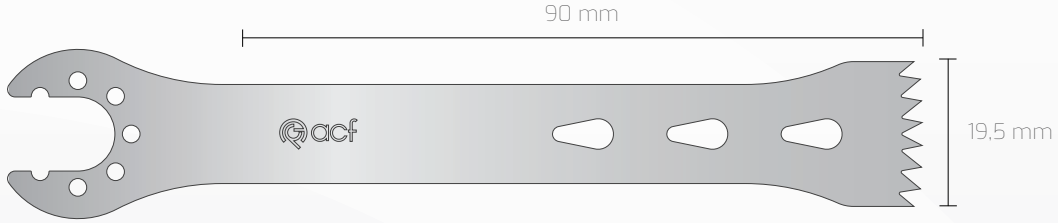

Ref	220 195 090 089	220 195 090 090	220 195 090 100	220 195 090 119	220 195 090 120
Kalınlık	0,89 mm	0,90 mm	1,00 mm	1,19 mm	1,20 mm

● Non Steril
 ● Steril R

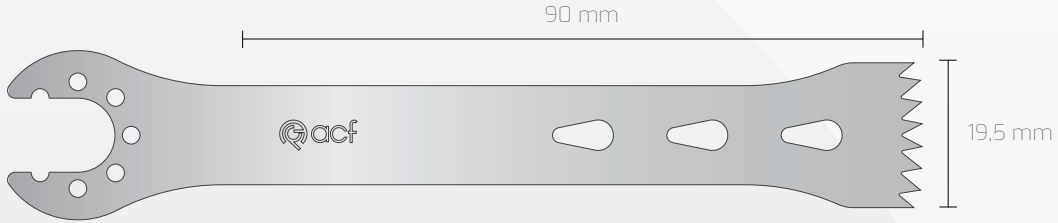

Ref	220 195 090 127	220 195 090 130	220 195 090 137	220 195 090 140	220 195 090 147
Kalınlık	1,27 mm	1,30 mm	1,37 mm	1,40 mm	1,47 mm

● Non Steril
 ● Steril R



Ref 220 195 090 150
Kalınlık 1,50 mm

Depuy Synthes®

Uyumlu Modeller;

Compact AirDrive II + Power Drive 511.800, 511.801, Air Power Line 511.610, Battery Power Line 530.610, TRS 05.001.224, 05.001.223, 05.001.240, Battery Power Line II 530.710

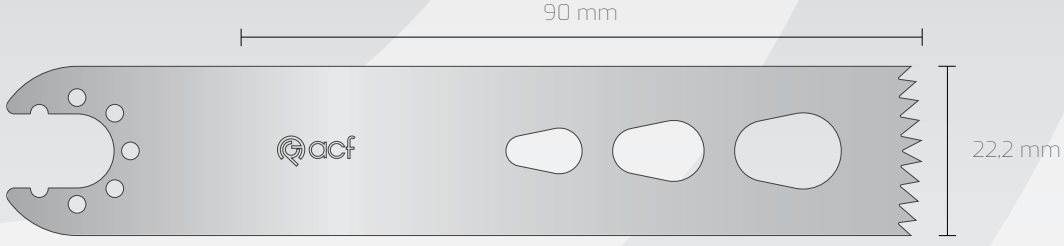

● Non Steril
● Steril R

Ref	220 222 090 089	220 222 090 090	220 222 090 100	220 222 090 119	220 222 090 120
Kalınlık	0,89 mm	0,90 mm	1,00 mm	1,19 mm	1,20 mm

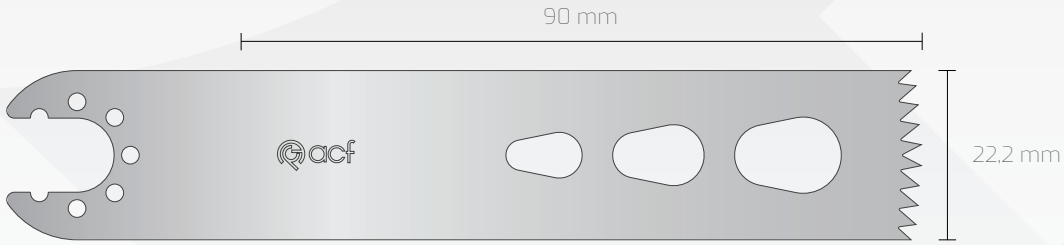

● Non Steril
● Steril R

Ref	220 222 090 127	220 222 090 130	220 222 090 137	220 222 090 140	220 222 090 147
Kalınlık	1,27 mm	1,30 mm	1,37 mm	1,40 mm	1,47 mm

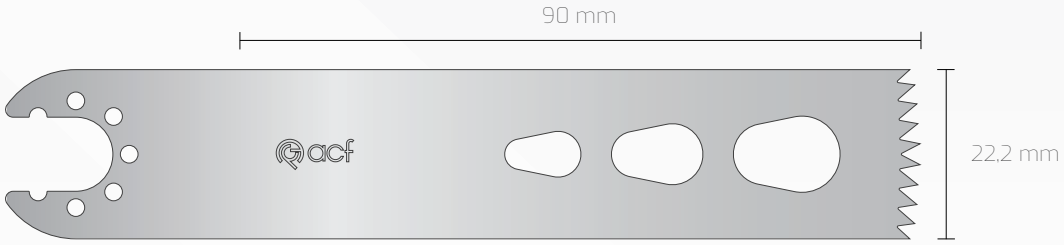

● Non Steril
● Steril R

Ref	220 222 090 150
Kalınlık	1,50 mm

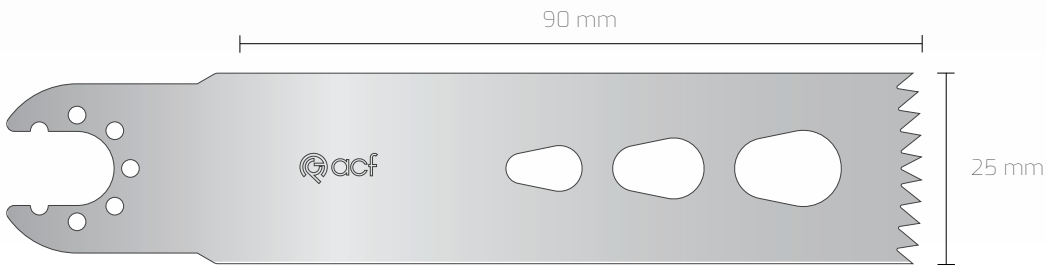

● Non Steril
● Steril R

Ref	220 250 090 089	220 250 090 090	220 250 090 100	220 250 090 119	220 250 090 120
Kalınlık	0,89 mm	0,90 mm	1,00 mm	1,19 mm	1,20 mm

Tüm testere bıçaklar gerçek ölçülerinde gösterilmiştir. 1:1

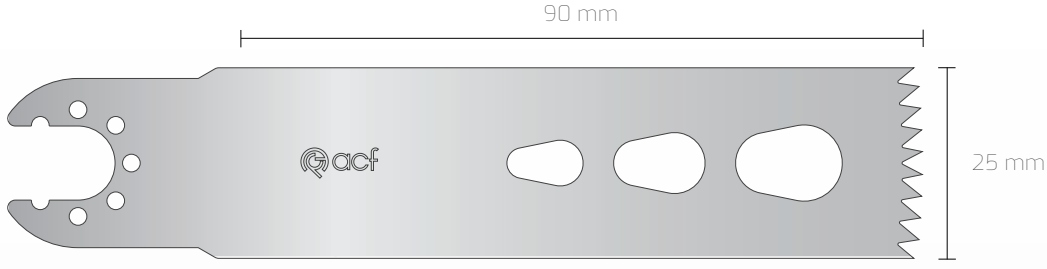

● Non Steril
● Steril R

Ref	220 250 090 127	220 250 090 130	220 250 090 137	220 250 090 140	220 250 090 147
Kalınlık	1,27 mm	1,30 mm	1,37 mm	1,40 mm	1,47 mm

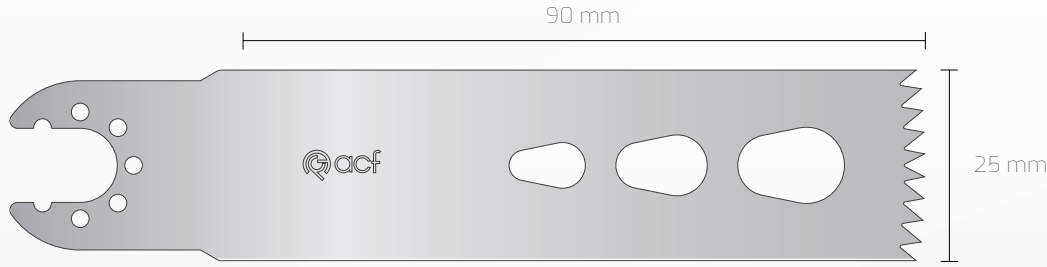

● Non Steril
● Steril R

Ref	220 250 090 150
Kalınlık	1,50 mm

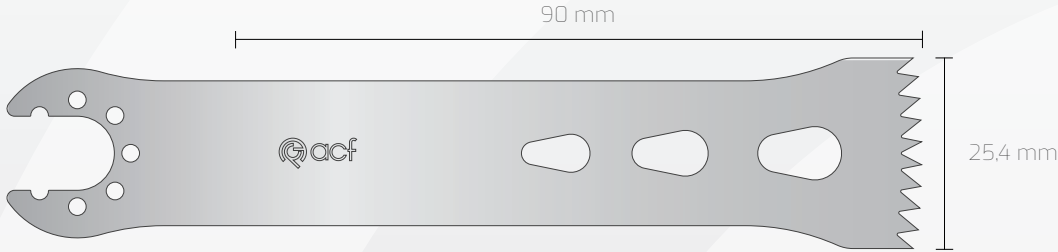

● Non Steril
● Steril R

Ref	220 254 090 089	220 254 090 090	220 254 090 100	220 254 090 119	220 254 090 120
Kalınlık	0,89 mm	0,90 mm	1,00 mm	1,19 mm	1,20 mm

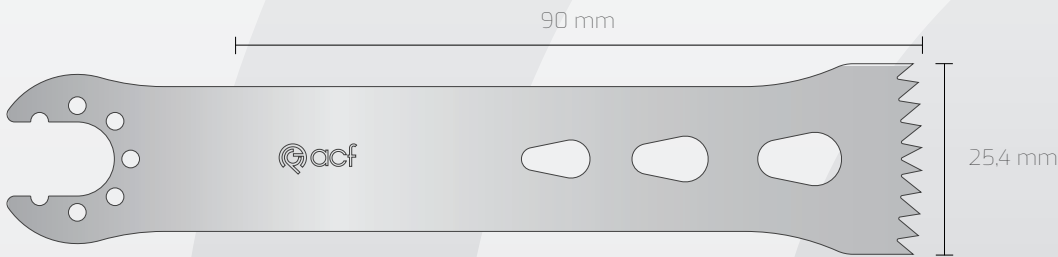

● Non Steril
● Steril R

Ref	220 254 090 127	220 254 090 130	220 254 090 137	220 254 090 140	220 254 090 147
Kalınlık	1,27 mm	1,30 mm	1,37 mm	1,40 mm	1,47 mm

Depuy Synthes®

Uyumlu Modeller;

Compact AirDrive II + Power Drive 511.800, 511.801, Air Power Line 511.610, Battery Power Line 530.610, TR5 05.001.224, 05.001.223, 05.001.240, Battery Power Line II 530.710

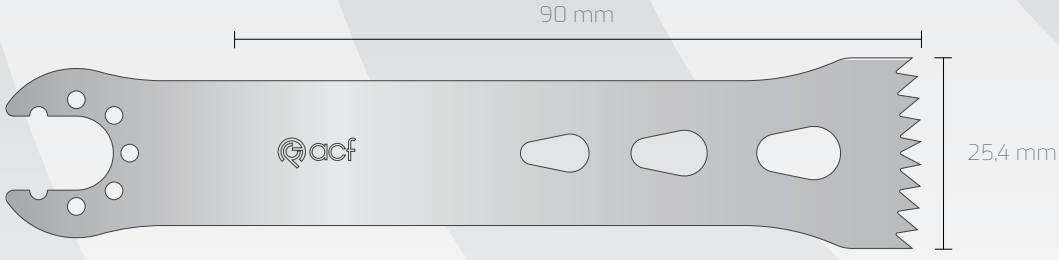

Non Steril
Steril R

Ref 220 254 090 150

Kalınlık 1,50 mm



Non Steril
Steril R

Ref 220 070 025 060

Kalınlık 0,60 mm

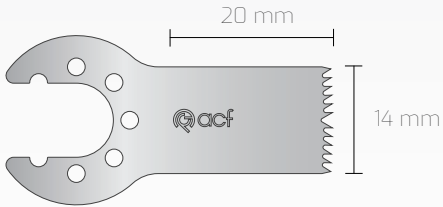

Non Steril
Steril R

Ref 220 140 020 060

Kalınlık 0,60 mm

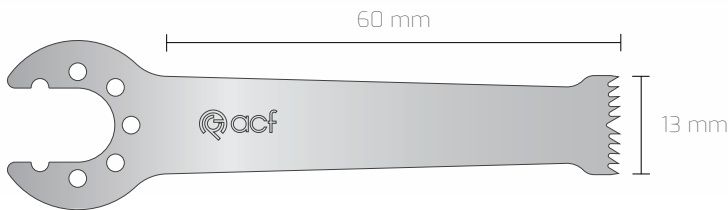

Non Steril
Steril R

Ref 220 130 060 090

Kalınlık 0,90 mm

DEPUY SYNTHES®

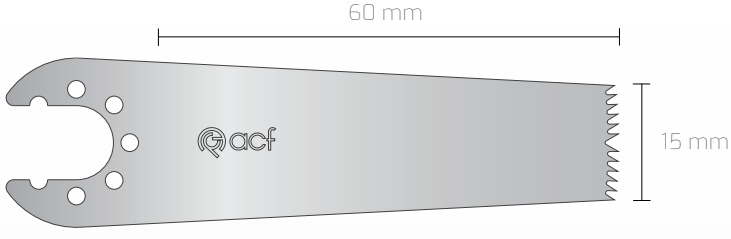

● Non Steril
● Steril R

Ref 220 150 060 090
Kalınlık 0,90 mm

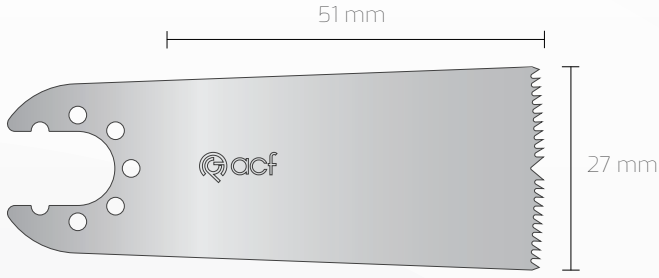

● Non Steril
● Steril R

Ref 220 270 051 060
Kalınlık 0,60 mm

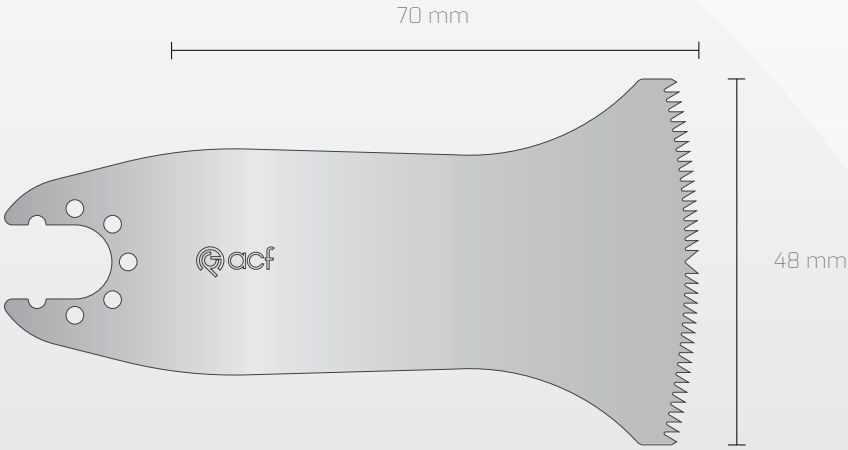

● Non Steril
● Steril R

Ref 220 480 070 060
Kalınlık 0,60 mm

Depuy Synthes®

Uyumlu Modeller;

Compact AirDrive II + Power Drive 511.800, 511.801, Air Power Line 511.610, Battery Power Line 530.610, TRS 05.001.224, 05.001.223, 05.001.240, Battery Power Line II 530.710



● Non Steril
● Steril R

Ref 220 490 070 090
Kalınlık 0,90 mm

DEPUY SYNTHES®

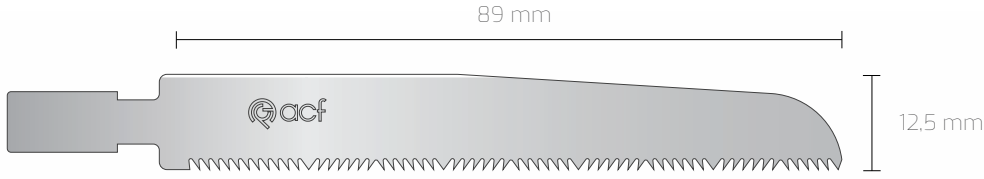

● Non Steril
 ● Steril R

Ref	220 125 089 090	220 125 089 100	220 125 089 120
Kalınlık	0,90 mm	1,00 mm	1,20 mm

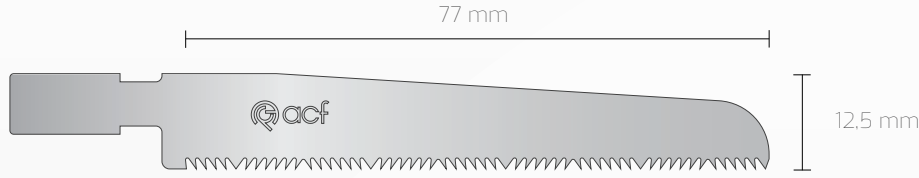

● Non Steril
 ● Steril R

Ref	220 125 077 090	220 125 077 100	220 125 077 120
Kalınlık	0,90 mm	1,00 mm	1,20 mm



● Non Steril
 ● Steril R

Ref	220 120 067 090	220 120 067 100	220 120 067 110	220 120 067 120
Kalınlık	0,90 mm	1,00 mm	1,10 mm	1,20 mm

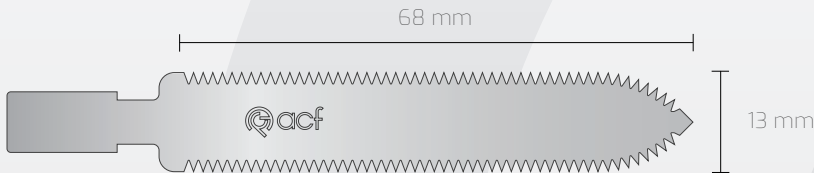

● Non Steril
 ● Steril R

Ref	220 130 068 090	220 130 068 100	220 130 068 120
Kalınlık	0,90 mm	1,00 mm	1,20 mm

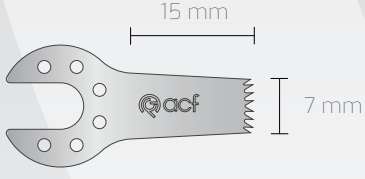

● Non Steril
● Steril R

Ref 220 070 015 060
Kalınlık 0,60 mm

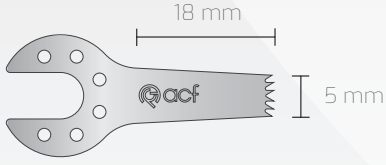

● Non Steril
● Steril R

Ref 220 050 018 060
Kalınlık 0,60 mm

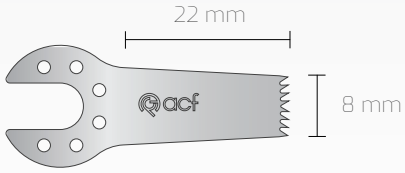

● Non Steril
● Steril R

Ref 220 080 022 060
Kalınlık 0,60 mm

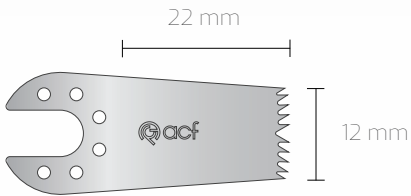

● Non Steril
● Steril R

Ref 220 120 022 060
Kalınlık 0,60 mm

● Non Steril
● Steril R

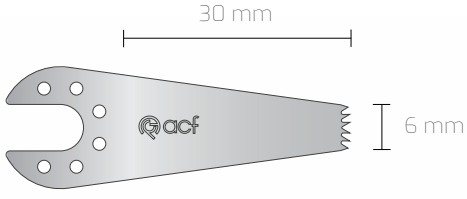

Ref 220 060 030 060
Kalınlık 0,60 mm

● Non Steril
● Steril R

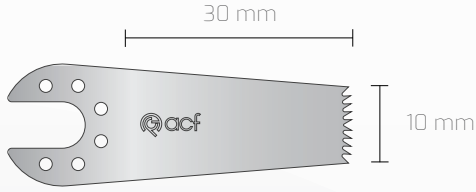

Ref 220 100 030 060
Kalınlık 0,60 mm

● Non Steril
● Steril R

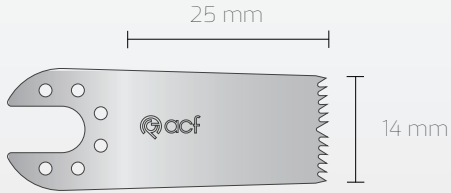

Ref 220 140 025 060
Kalınlık 0,60 mm

● Non Steril
● Steril R

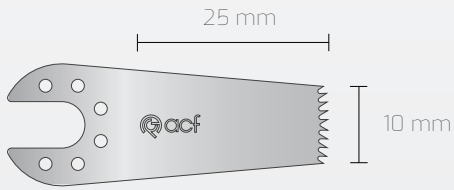

Ref 220 100 025 060
Kalınlık 0,60 mm

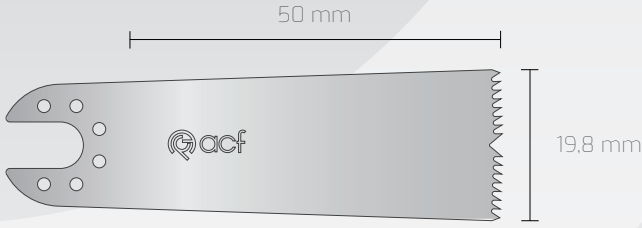

● Non Steril
● Steril R

Ref 220 198 050 060
Kalınlık 0,60 mm

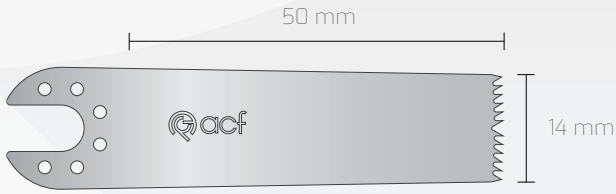

● Non Steril
● Steril R

Ref 220 140 050 060
Kalınlık 0,60 mm

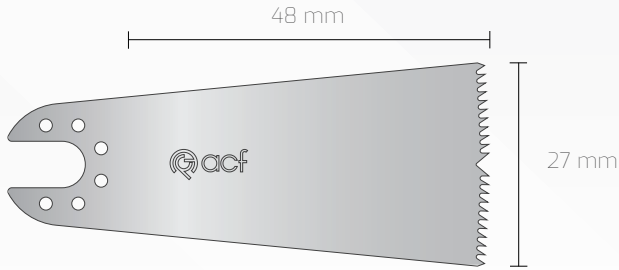

● Non Steril
● Steril R

Ref 220 270 048 060
Kalınlık 0,60 mm

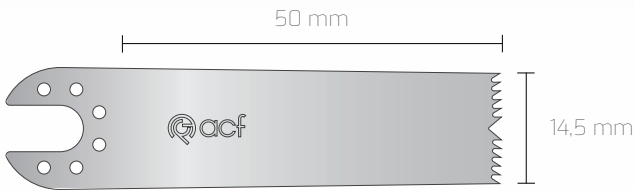

● Non Steril
● Steril R

Ref 220 145 050 060
Kalınlık 0,60 mm

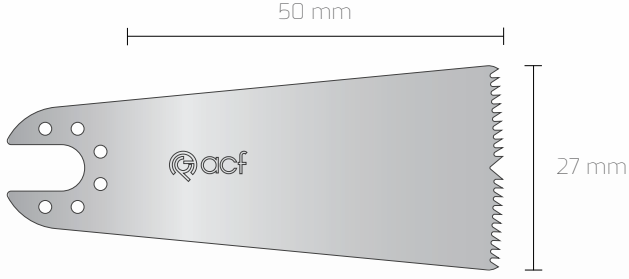

● Non Steril
● Steril R

Ref 220 270 050 060
Kalınlık 0,60 mm



ZIMMER[®]
ile Uyumlu
Testere Bıçaklar



Marka Kodu **220**

Dik Kesen Testere Bıçaklar İçin
223

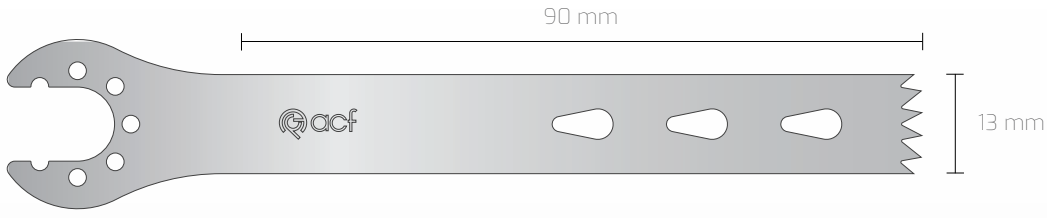

● Non Steril
 ● Steril R

Ref	220 130 090 089	220 130 090 090	220 130 090 100	220 130 090 119	220 130 090 120
Kalınlık	0,89 mm	0,90 mm	1,00 mm	1,19 mm	1,20 mm

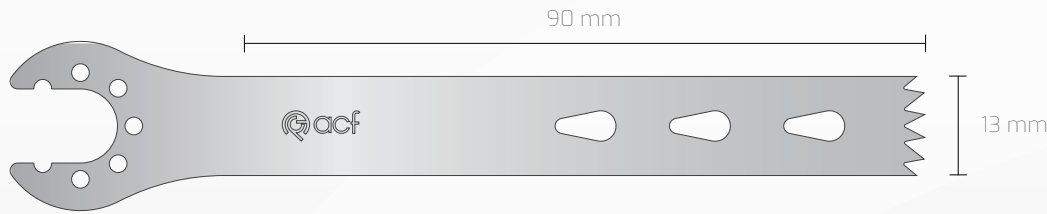

● Non Steril
 ● Steril R

Ref	220 130 090 127	220 130 090 130	220 130 090 137	220 130 090 140	220 130 090 147
Kalınlık	1,27 mm	1,30 mm	1,37 mm	1,40 mm	1,47 mm

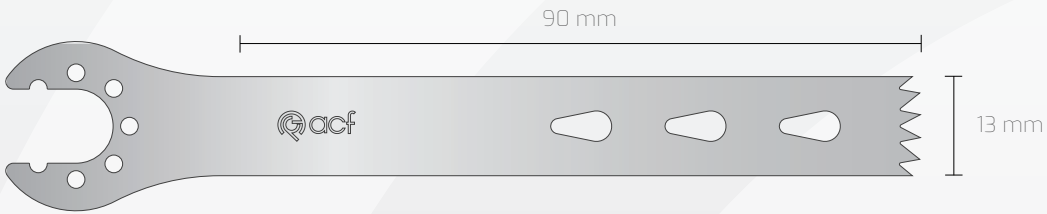

● Non Steril
 ● Steril R

Ref	220 130 090 150
Kalınlık	1,50 mm

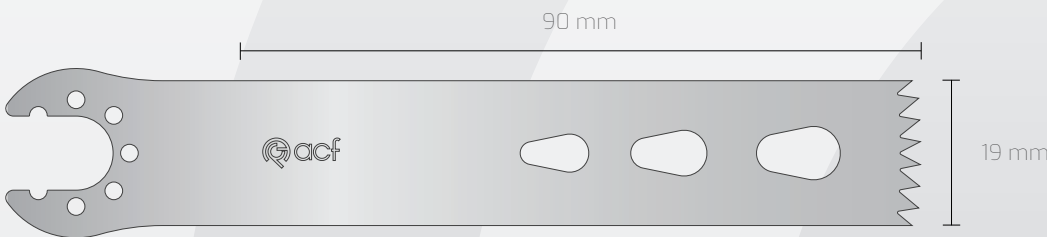

● Non Steril
 ● Steril R

Ref	220 190 090 089	220 190 090 090	220 190 090 100	220 190 090 119	220 190 090 120
Kalınlık	0,89 mm	0,90 mm	1,00 mm	1,19 mm	1,20 mm

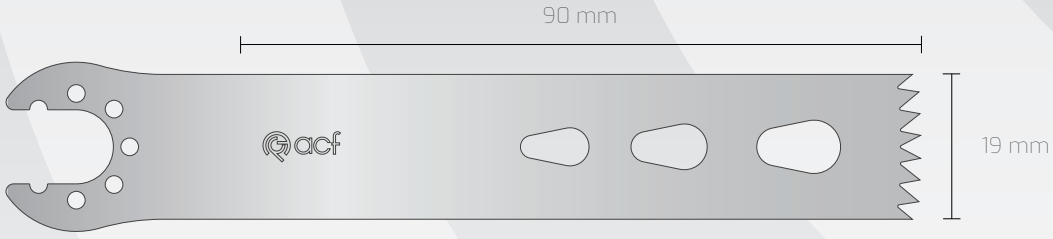

● Non Steril
● Steril R

Ref	220 190 090 127	220 190 090 130	220 190 090 137	220 190 090 140	220 190 090 147
Kalınlık	1,27 mm	1,30 mm	1,37 mm	1,40 mm	1,47 mm

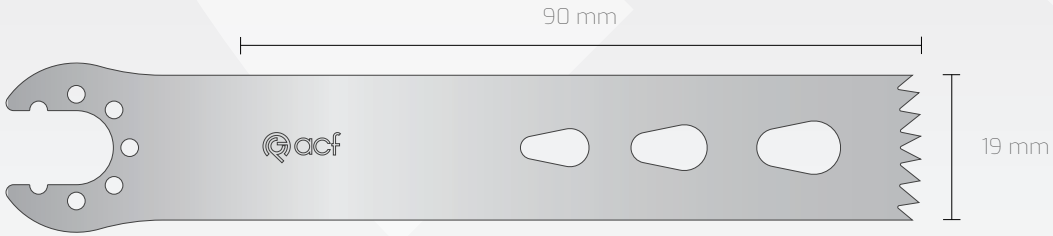

● Non Steril
● Steril R

Ref	220 190 090 150
Kalınlık	1,50 mm

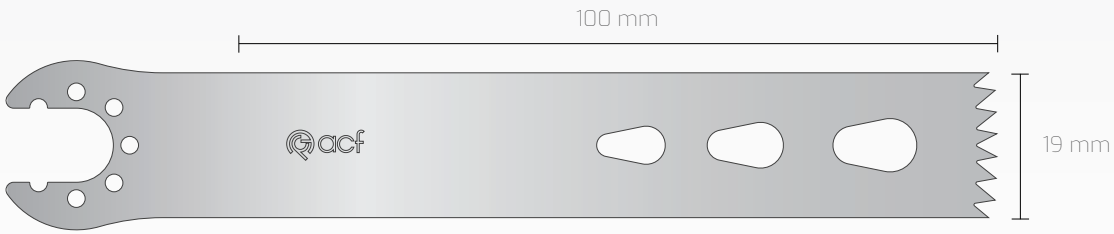

● Non Steril
● Steril R

Ref	220 190 100 089	220 190 100 090	220 190 100 100	220 190 100 119	220 190 100 120
Kalınlık	0,89 mm	0,90 mm	1,00 mm	1,19 mm	1,20 mm

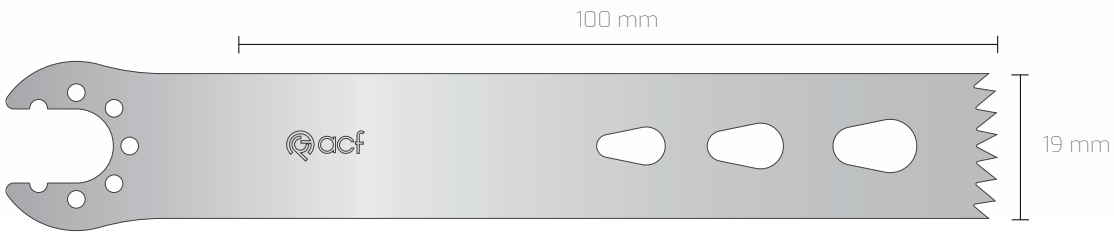

● Non Steril
● Steril R

Ref	220 190 100 127	220 190 100 130	220 190 100 137	220 190 100 140	220 190 100 147
Kalınlık	1,27 mm	1,30 mm	1,37 mm	1,40 mm	1,47 mm

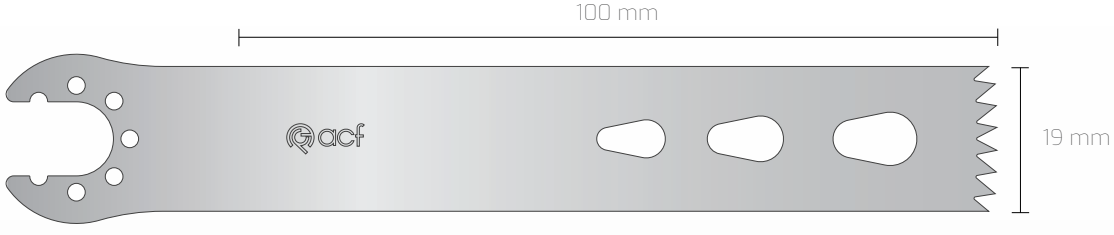

● Non Steril
 ● Steril R

Ref 220 190 100 150
Kalınlık 1,50 mm

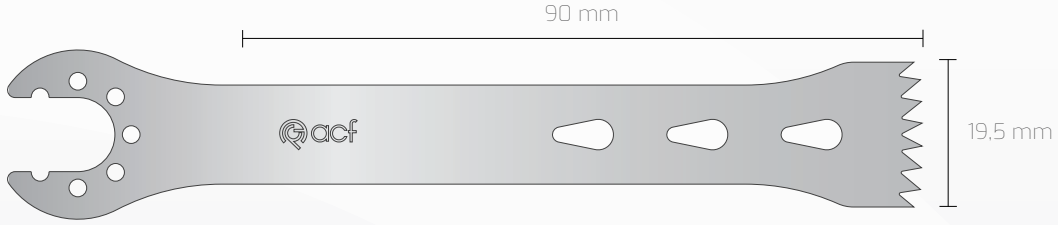

● Non Steril
 ● Steril R

Ref	220 195 090 089	220 195 090 090	220 195 090 100	220 195 090 119	220 195 090 120
Kalınlık	0,89 mm	0,90 mm	1,00 mm	1,19 mm	1,20 mm

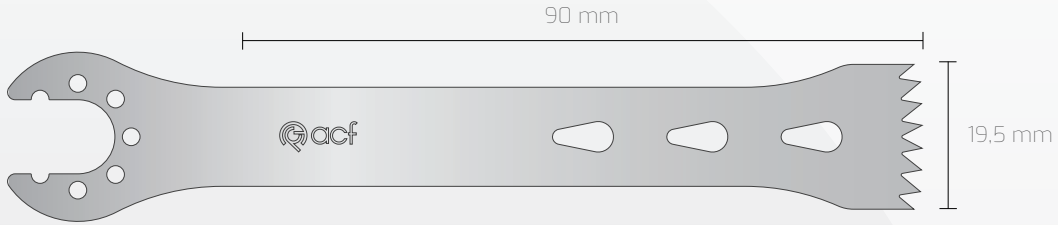

● Non Steril
 ● Steril R

Ref	220 195 090 127	220 195 090 130	220 195 090 137	220 195 090 140	220 195 090 147
Kalınlık	1,27 mm	1,30 mm	1,37 mm	1,40 mm	1,47 mm

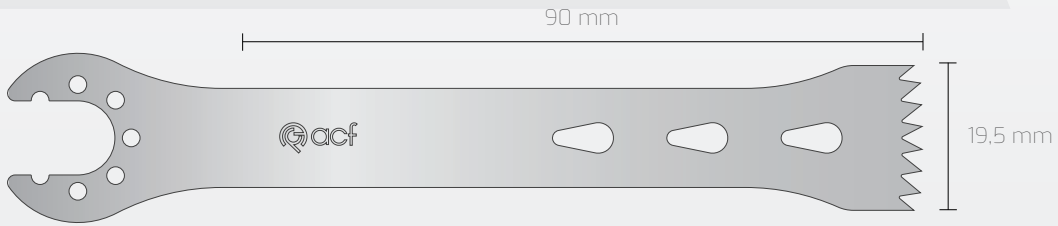

● Non Steril
 ● Steril R

Ref 220 195 090 150
Kalınlık 1,50 mm

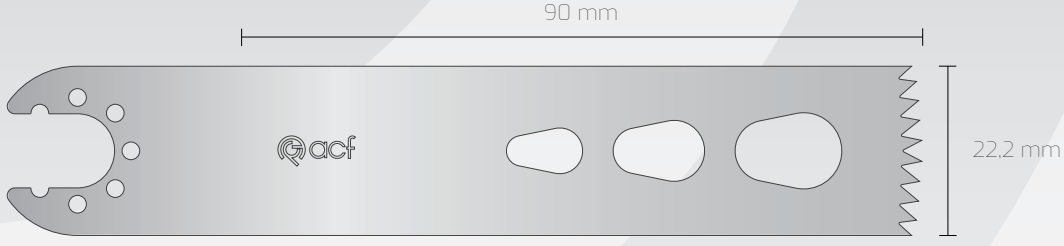

● Non Steril
● Steril R

Ref	220 222 090 089	220 222 090 090	220 222 090 100	220 222 090 119	220 222 090 120
Kalınlık	0,89 mm	0,90 mm	1,00 mm	1,19 mm	1,20 mm

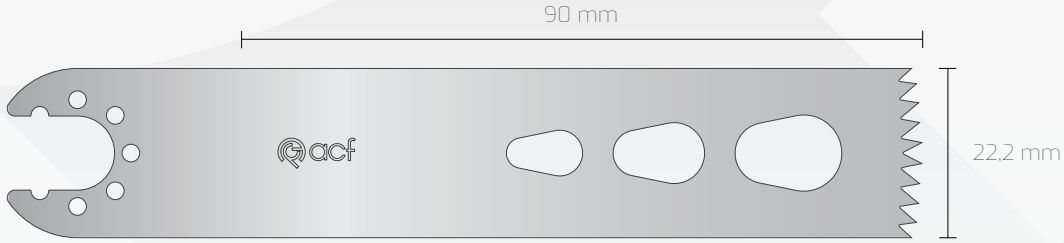

● Non Steril
● Steril R

Ref	220 222 090 127	220 222 090 130	220 222 090 137	220 222 090 140	220 222 090 147
Kalınlık	1,27 mm	1,30 mm	1,37 mm	1,40 mm	1,47 mm

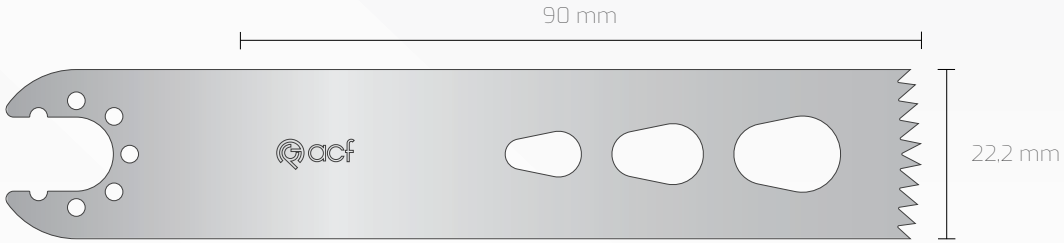

● Non Steril
● Steril R

Ref	220 222 090 150
Kalınlık	1,50 mm

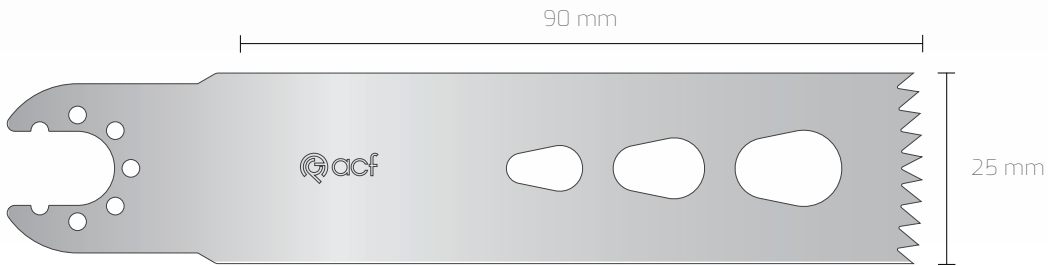

● Non Steril
● Steril R

Ref	220 250 090 089	220 250 090 090	220 250 090 100	220 250 090 119	220 250 090 120
Kalınlık	0,89 mm	0,90 mm	1,00 mm	1,19 mm	1,20 mm

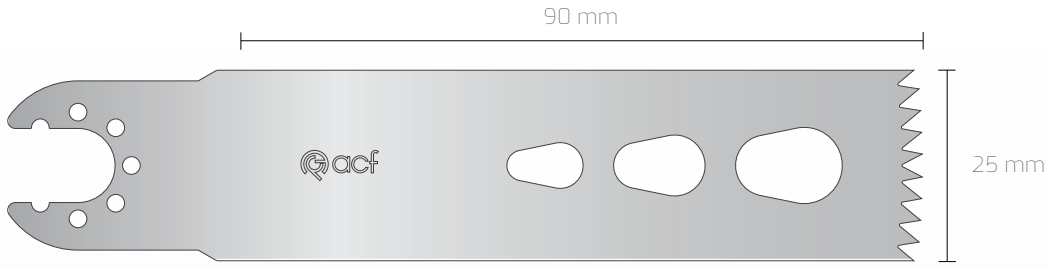

● Non Steril
 ● Steril R

Ref	220 250 090 127	220 250 090 130	220 250 090 137	220 250 090 140	220 250 090 147
Kalınlık	1,27 mm	1,30 mm	1,37 mm	1,40 mm	1,47 mm

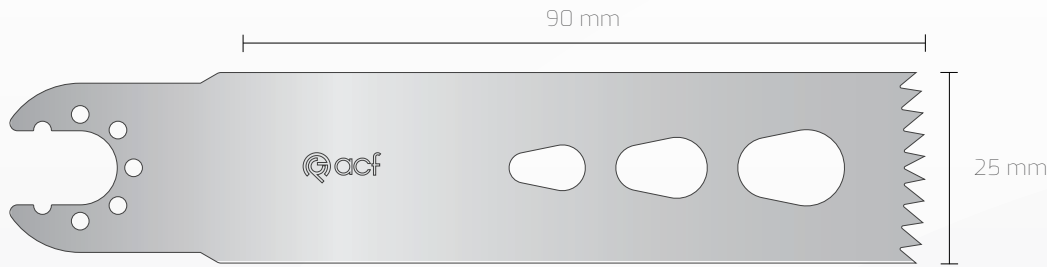

● Non Steril
 ● Steril R

Ref	220 250 090 150
Kalınlık	1,50 mm

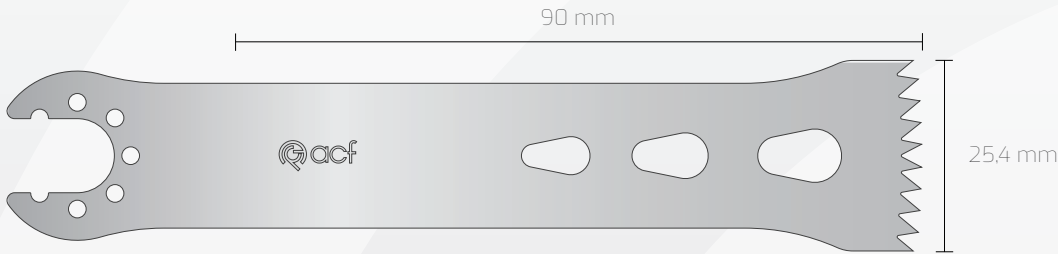

● Non Steril
 ● Steril R

Ref	220 254 090 089	220 254 090 090	220 254 090 100	220 254 090 119	220 254 090 120
Kalınlık	0,89 mm	0,90 mm	1,00 mm	1,19 mm	1,20 mm

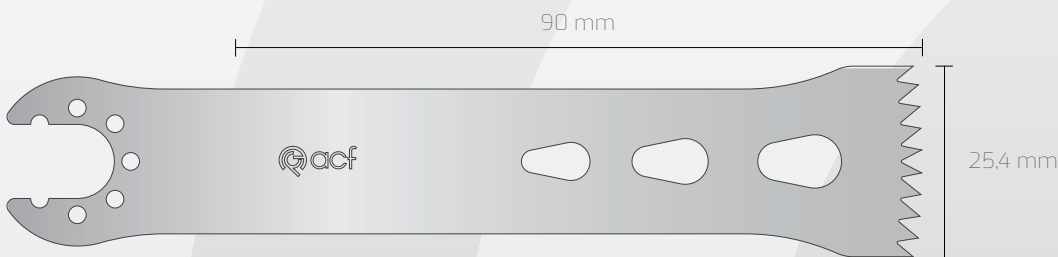

● Non Steril
 ● Steril R

Ref	220 254 090 127	220 254 090 130	220 254 090 137	220 254 090 140	220 254 090 147
Kalınlık	1,27 mm	1,30 mm	1,37 mm	1,40 mm	1,47 mm

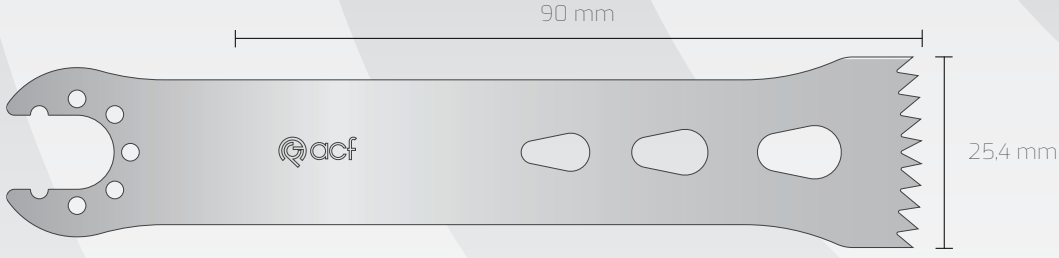

● Non Steril
● Steril R

Ref 220 254 090 150
Kalınlık 1,50 mm

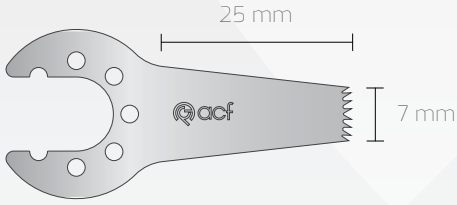

● Non Steril
● Steril R

Ref 220 070 025 060
Kalınlık 0,60 mm

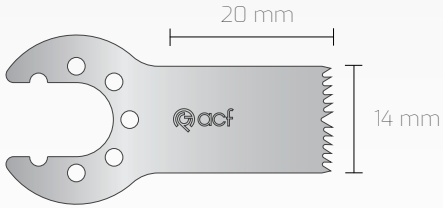

● Non Steril
● Steril R

Ref 220 140 020 060
Kalınlık 0,60 mm

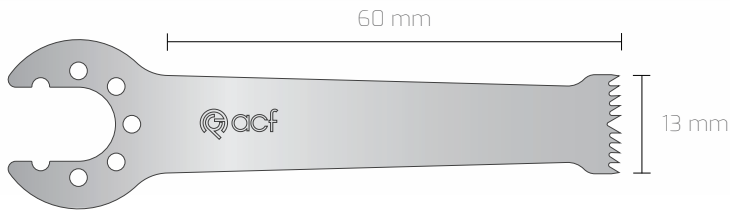

● Non Steril
● Steril R

Ref 220 130 060 090
Kalınlık 0,90 mm

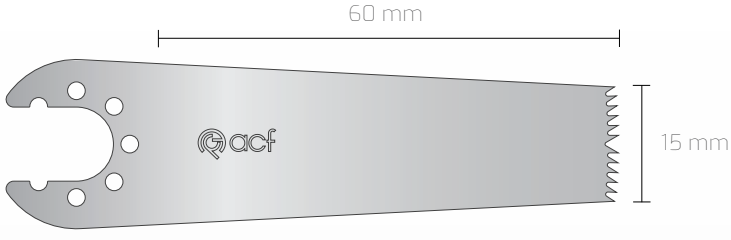

 Non Steril

 Steril R

Ref 220 150 060 090

Kalınlık 0,90 mm

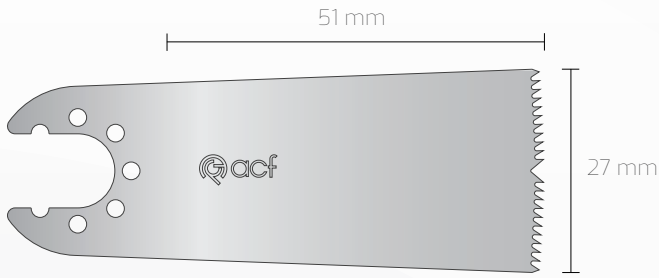

 Non Steril

 Steril R

Ref 220 270 051 060

Kalınlık 0,60 mm

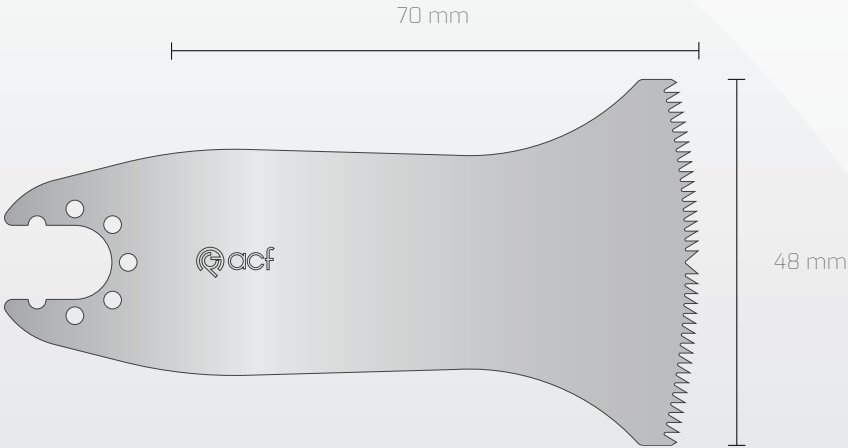

 Non Steril

 Steril R

Ref 220 480 070 060

Kalınlık 0,60 mm

Zimmer®
Uyumlu Modeller;
Zimmer Universal Power System,
89-8509-450-60



● Non Steril
● Steril R

Ref 220 490 070 090
Kalınlık 0,90 mm

ZIMMER®

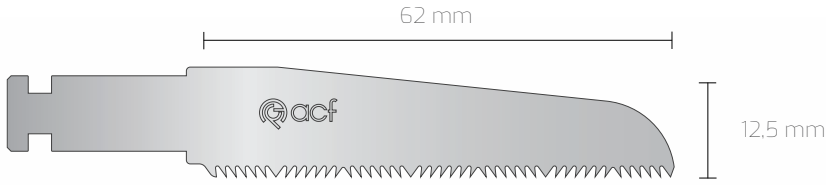

● Non Steril
 ● Steril R

Ref	223 125 062 090	223 125 062 100	223 125 062 120
Kalınlık	0,90 mm	1,00 mm	1,20 mm

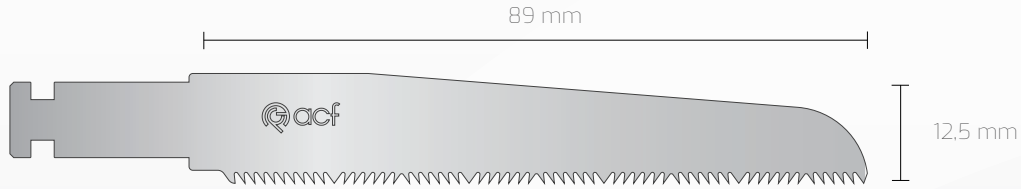

● Non Steril
 ● Steril R

Ref	223 125 089 090	223 125 089 100	223 125 089 120
Kalınlık	0,90 mm	1,00 mm	1,20 mm

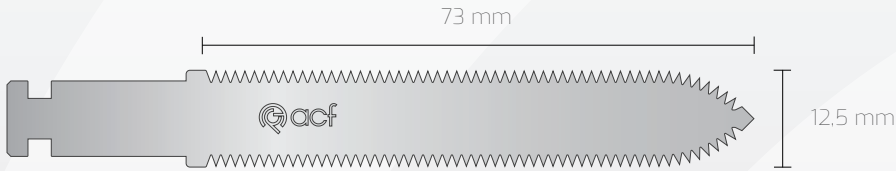

● Non Steril
 ● Steril R

Ref	223 125 073 090	223 125 073 100	223 125 073 120
Kalınlık	0,90 mm	1,00 mm	1,20 mm

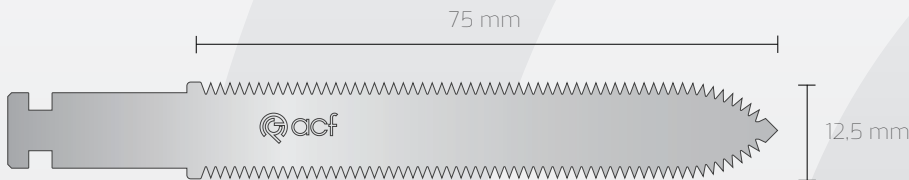

● Non Steril
 ● Steril R

Ref	223 125 075 090	223 125 075 100	223 125 075 120
Kalınlık	0,90 mm	1,00 mm	1,20 mm

Zimmer®

Uyumlu Modeller;

Zimmer Universal Power System,
89-8509-451-20

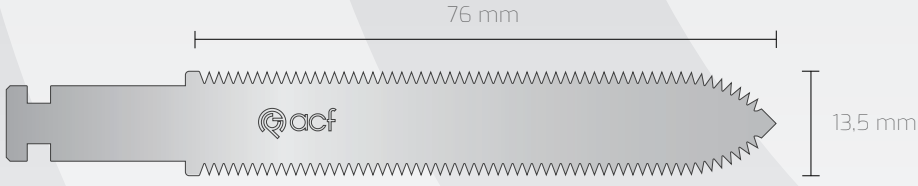

● Non Steril
● Steril R

Ref	223 135 076 090	223 135 076 100	223 135 076 120
Kalınlık	0,90 mm	1,00 mm	1,20 mm

ZIMMER®



BRASSELER[®] / TAVA[®]
ile Uyumlu
Testere Bıçaklar



Marka Kodu **260**

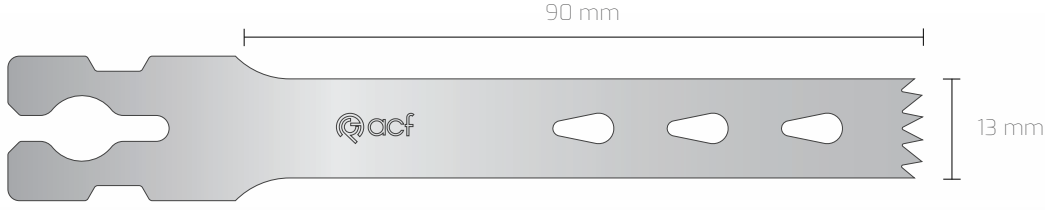

● Non Steril
● Steril R

Ref	260 130 090 089	260 130 090 090	260 130 090 100	260 130 090 119	260 130 090 120
Kalınlık	0,89 mm	0,90 mm	1,00 mm	1,19 mm	1,20 mm

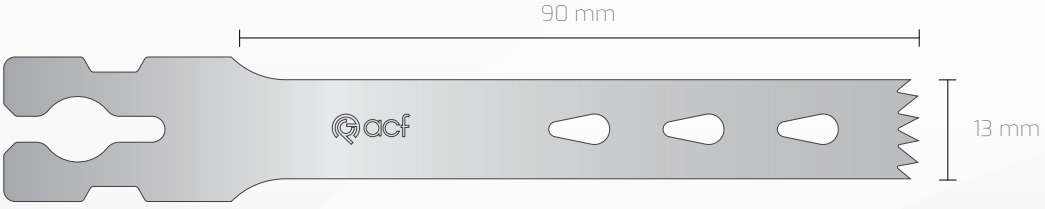

● Non Steril
● Steril R

Ref	260 130 090 127	260 130 090 130	260 130 090 137	260 130 090 140	260 130 090 147
Kalınlık	1,27 mm	1,30 mm	1,37 mm	1,40 mm	1,47 mm

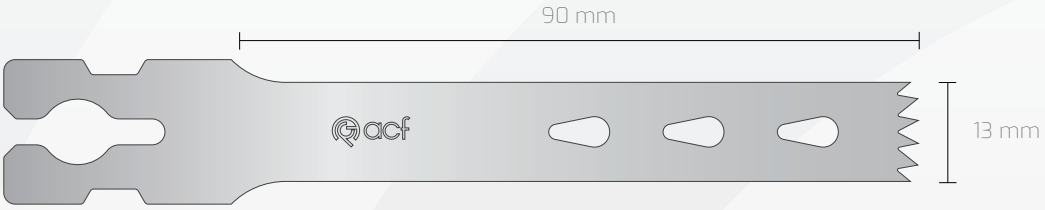

● Non Steril
● Steril R

Ref	260 130 090 150
Kalınlık	1,50 mm

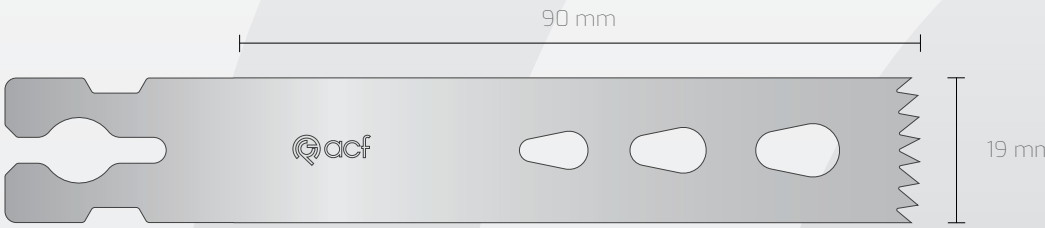

● Non Steril
● Steril R

Ref	260 190 090 089	260 190 090 090	260 190 090 100	260 190 090 119	260 190 090 120
Kalınlık	0,89 mm	0,90 mm	1,00 mm	1,19 mm	1,20 mm

Brasseler® / Tava®
Uyumlu Modeller;
Tüm Brasseler® ve Tava®
Kesici Sistemleri
(Sagittal/Oscillator Saw Systems)

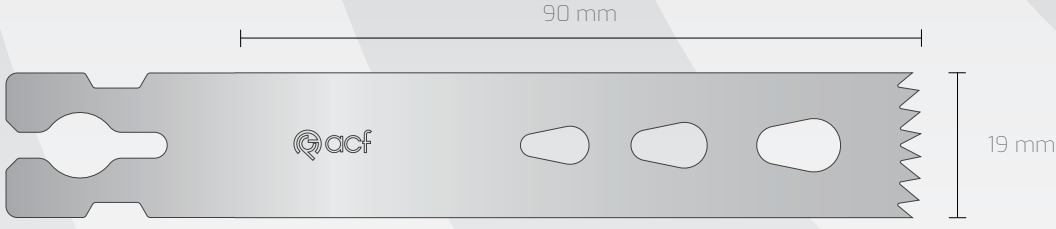

● Non Steril
● Steril R

Ref	260 190 090 127	260 190 090 130	260 190 090 137	260 190 090 140	260 190 090 147
Kalınlık	1,27 mm	1,30 mm	1,37 mm	1,40 mm	1,47 mm

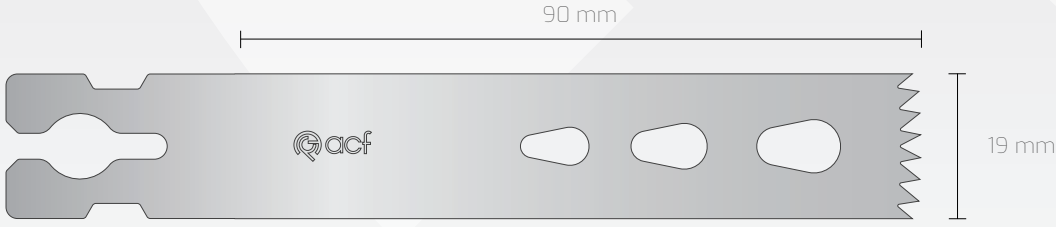

● Non Steril
● Steril R

Ref	260 190 090 150
Kalınlık	1,50 mm

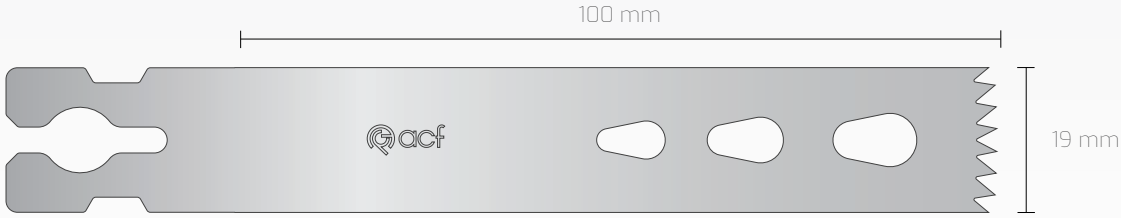

● Non Steril
● Steril R

Ref	260 190 100 089	260 190 100 090	260 190 100 100	260 190 100 119	260 190 100 120
Kalınlık	0,89 mm	0,90 mm	1,00 mm	1,19 mm	1,20 mm

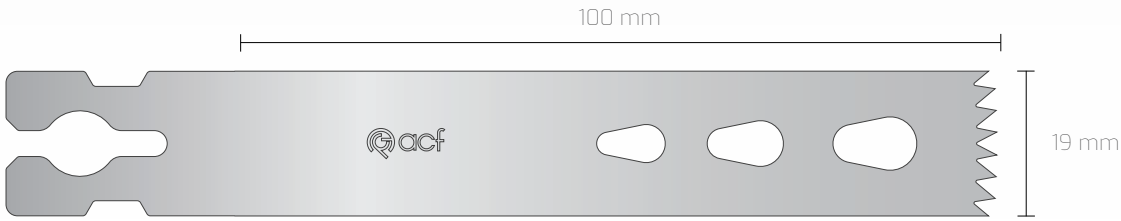

● Non Steril
● Steril R

Ref	260 190 100 127	260 190 100 130	260 190 100 137	260 190 100 140	260 190 100 147
Kalınlık	1,27 mm	1,30 mm	1,37 mm	1,40 mm	1,47 mm

BRASSELER® / TAVA®

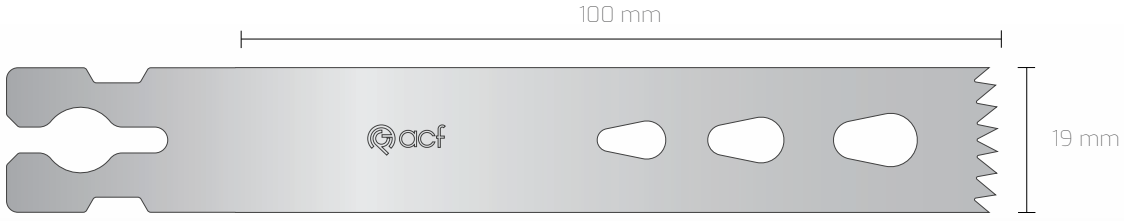

● Non Steril
 ● Steril R

Ref 260 190 100 150
Kalınlık 1,50 mm

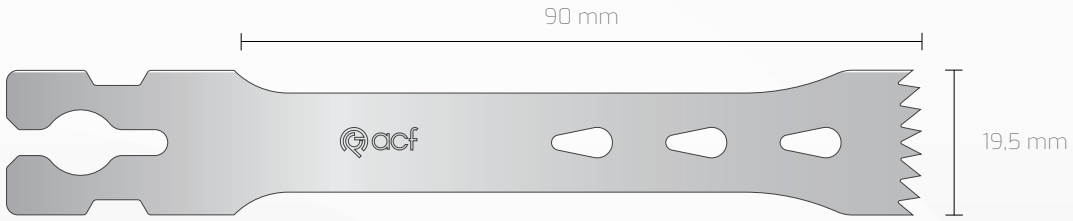

● Non Steril
 ● Steril R

Ref	260 195 090 089	260 195 090 090	260 195 090 100	260 195 090 119	260 195 090 120
Kalınlık	0,89 mm	0,90 mm	1,00 mm	1,19 mm	1,20 mm

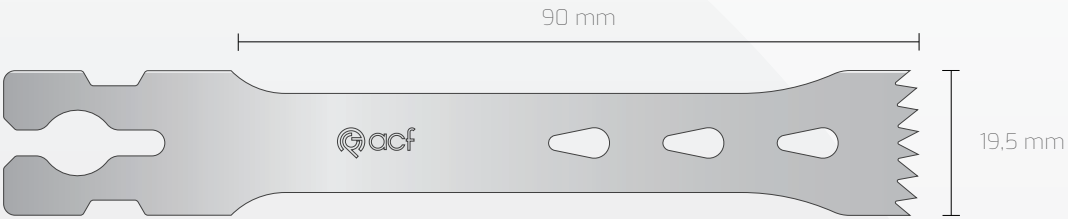

● Non Steril
 ● Steril R

Ref	260 195 090 127	260 195 090 130	260 195 090 137	260 195 090 140	260 195 090 147
Kalınlık	1,27 mm	1,30 mm	1,37 mm	1,40 mm	1,47 mm

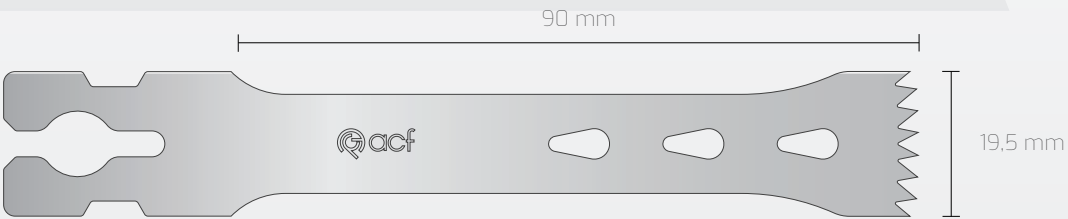

● Non Steril
 ● Steril R

Ref 260 195 090 150
Kalınlık 1,50 mm

Brasseler® / Tava®
Uyumlu Modeller;
Tüm Brasseler® ve Tava®
Kesici Sistemleri
(Sagittal/Oscillator Saw Systems)

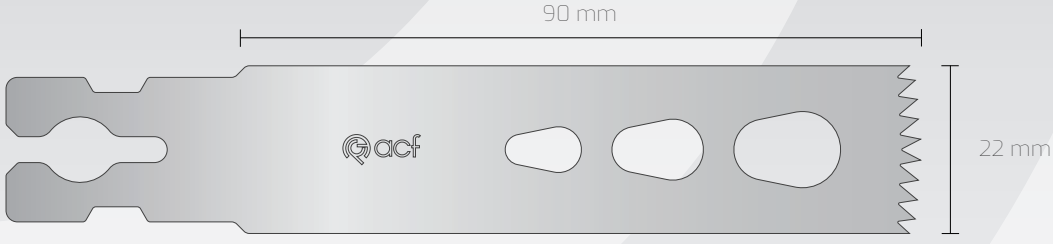

● Non Steril
● Steril R

Ref	260 220 090 089	260 220 090 090	260 220 090 100	260 220 090 119	260 220 090 120
Kalınlık	0,89 mm	0,90 mm	1,00 mm	1,19 mm	1,20 mm

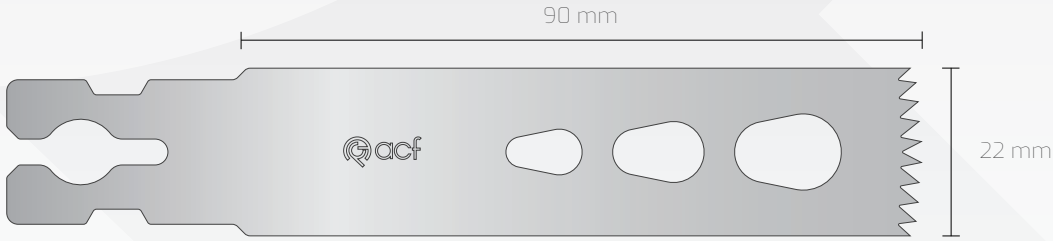

● Non Steril
● Steril R

Ref	260 220 090 127	260 220 090 130	260 220 090 137	260 220 090 140	260 220 090 147
Kalınlık	1,27 mm	1,30 mm	1,37 mm	1,40 mm	1,47 mm

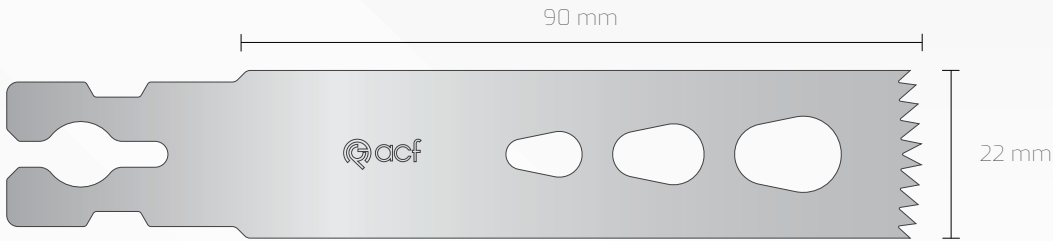

● Non Steril
● Steril R

Ref	260 220 090 150
Kalınlık	1,50 mm

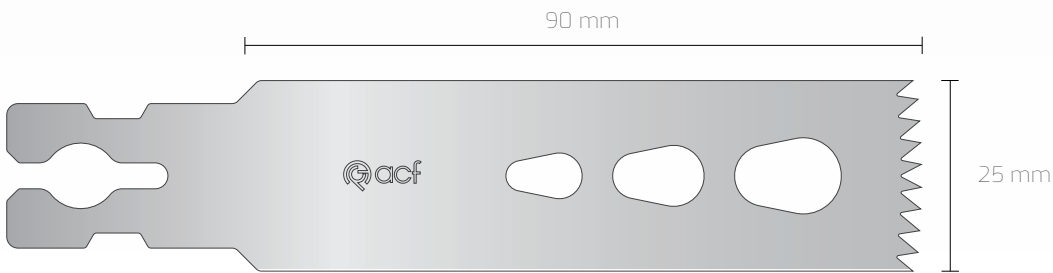

● Non Steril
● Steril R

Ref	260 250 090 089	260 250 090 090	260 250 090 100	260 250 090 119	260 250 090 120
Kalınlık	0,89 mm	0,90 mm	1,00 mm	1,19 mm	1,20 mm

BRASSELER® / TAVA®

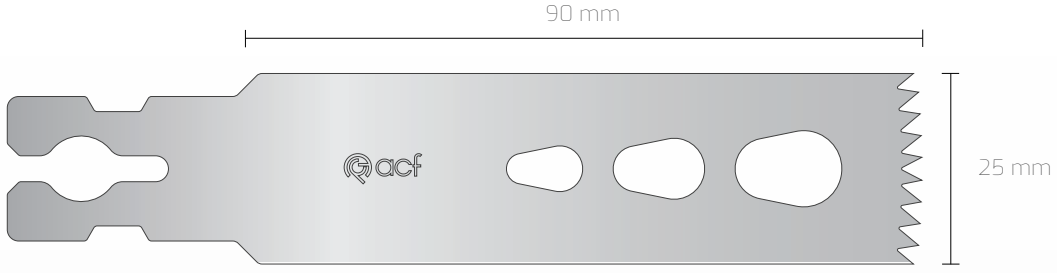

● Non Steril
 ● Steril R

Ref	260 250 090 127	260 250 090 130	260 250 090 137	260 250 090 140	260 250 090 147
Kalınlık	1,27 mm	1,30 mm	1,37 mm	1,40 mm	1,47 mm

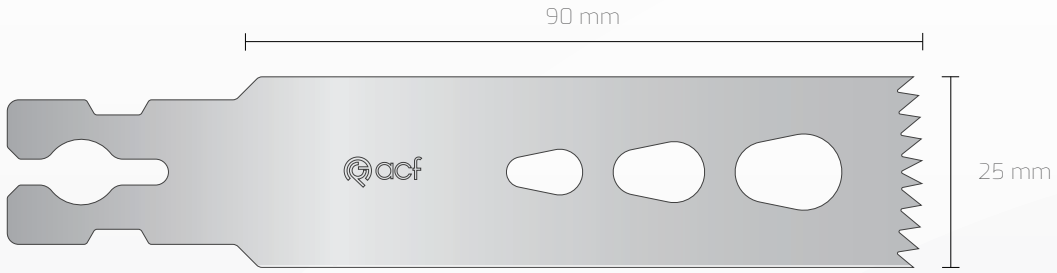

● Non Steril
 ● Steril R

Ref	260 250 090 150
Kalınlık	1,50 mm

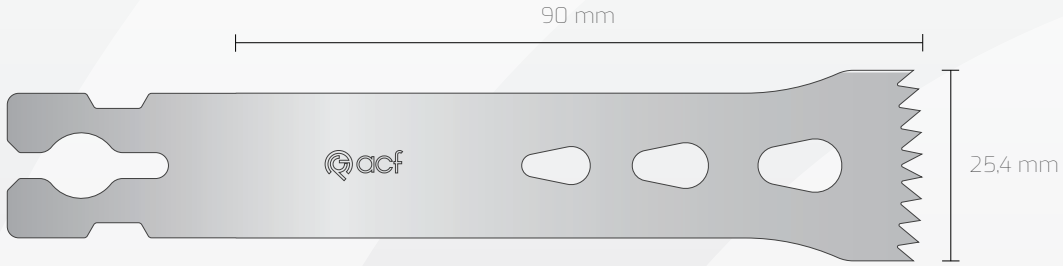

● Non Steril
 ● Steril R

Ref	260 254 090 089	260 254 090 090	260 254 090 100	260 254 090 119	260 254 090 120
Kalınlık	0,89 mm	0,90 mm	1,00 mm	1,19 mm	1,20 mm



● Non Steril
 ● Steril R

Ref	260 254 090 127	260 254 090 130	260 254 090 137	260 254 090 140	260 254 090 147
Kalınlık	1,27 mm	1,30 mm	1,37 mm	1,40 mm	1,47 mm

Brasseler® / Tava®
Uyumlu Modeller;
Tüm Brasseler® ve Tava®
Kesici Sistemleri
(Sagittal/Oscillator Saw Systems)

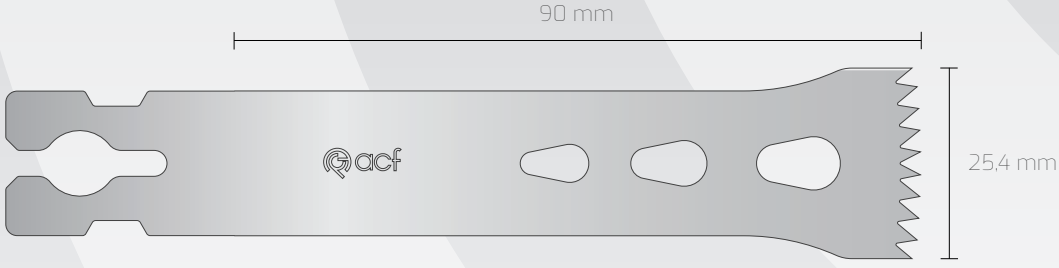

● Non Steril
● Steril R

Ref 260 254 090 150
Kalınlık 1,50 mm



● Non Steril
● Steril R

Ref 260 055 025 060
Kalınlık 0,60 mm

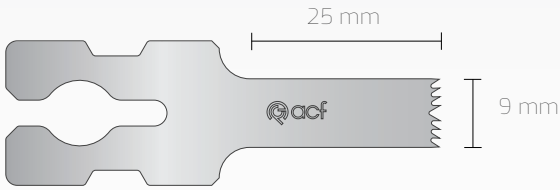

● Non Steril
● Steril R

Ref 260 090 025 060
Kalınlık 0,60 mm

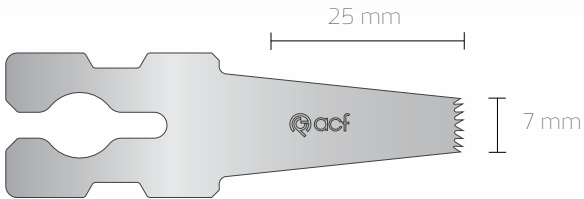

● Non Steril
● Steril R

Ref 260 070 025 060
Kalınlık 0,60 mm

BRASSELER® / TAVA®

● Non Steril
● Steril R

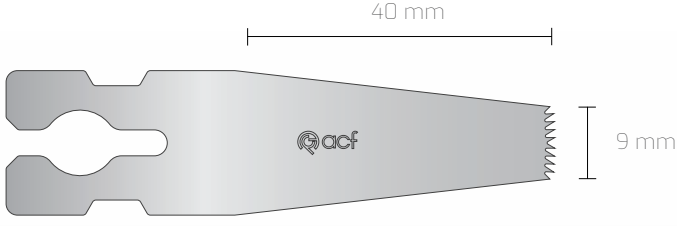

Ref 260 090 040 060
Kalınlık 0,60 mm

● Non Steril
● Steril R

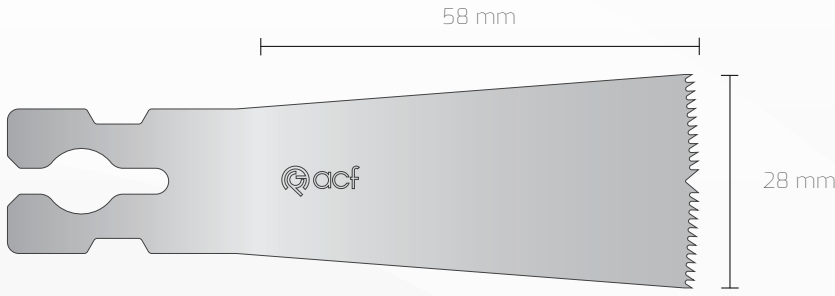

Ref 260 280 058 060
Kalınlık 0,60 mm

● Non Steril
● Steril R

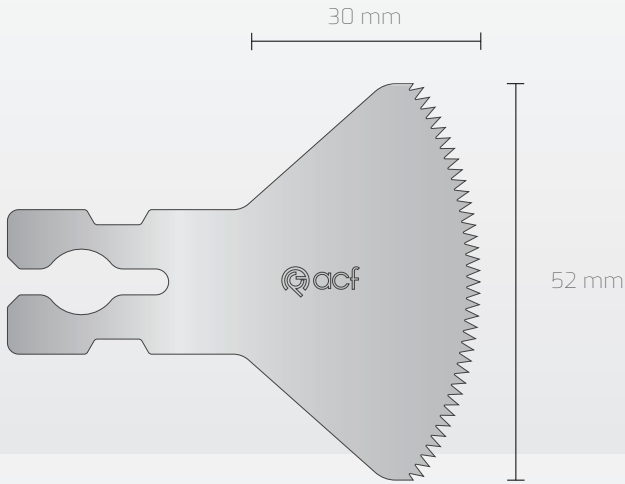

Ref 260 520 030 060 260 520 030 090
Kalınlık 0,60 mm 0,90 mm

Brasseler® / Tava®

Uyumlu Modeller;
Tüm Brasseler® ve Tava®
Kesici Sistemleri
(Sagittal/Oscillator Saw Systems)

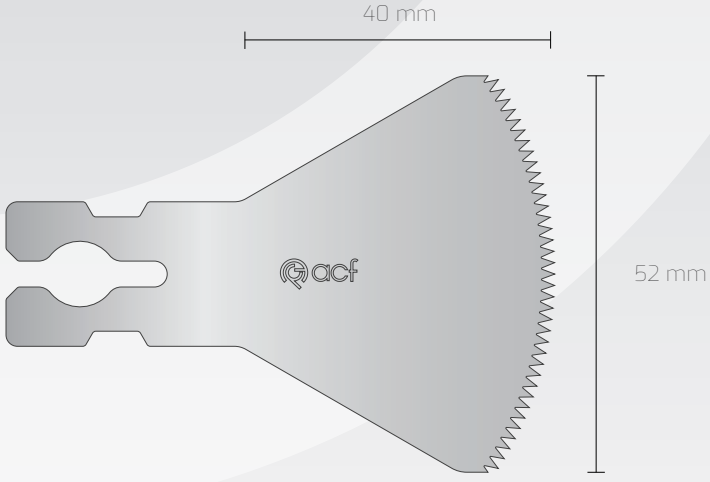

● Non Steril
● Steril R

Ref	260 520 040 060	260 520 040 090
Kalınlık	0,60 mm	0,90 mm

BRASSELER® / TAVA®



**B BRAUN AESCULAP®
ile Uyumlu
Testere Bıçaklar**

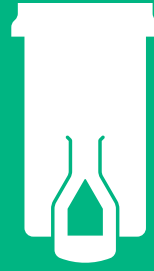

Marka Kodu **320**

330

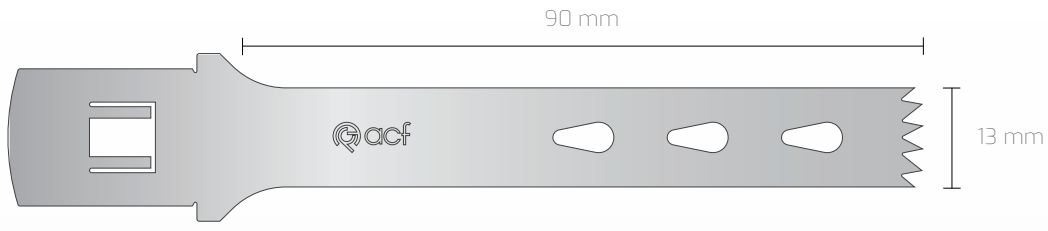

● Non Steril
● Steril R

Ref	320 130 090 089	320 130 090 090	320 130 090 100	320 130 090 119	320 130 090 120
Kalınlık	0,89 mm	0,90 mm	1,00 mm	1,19 mm	1,20 mm

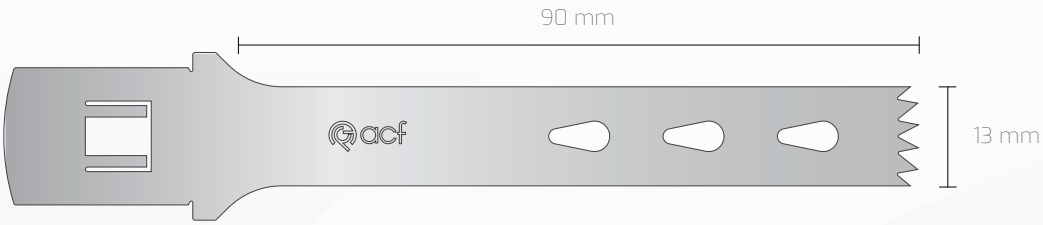

● Non Steril
● Steril R

Ref	320 130 090 127	320 130 090 130	320 130 090 137	320 130 090 140	320 130 090 147
Kalınlık	1,27 mm	1,30 mm	1,37 mm	1,40 mm	1,47 mm

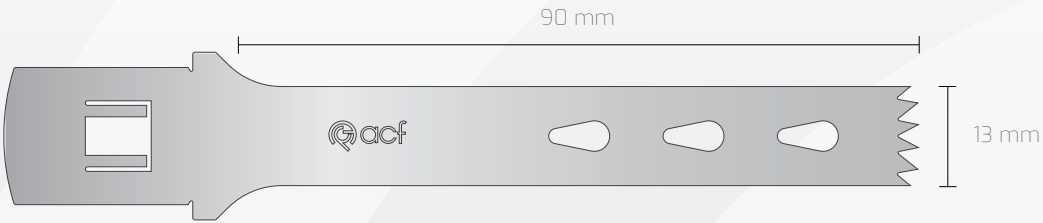

● Non Steril
● Steril R

Ref	320 130 090 150
Kalınlık	1,50 mm



● Non Steril
● Steril R

Ref	320 190 090 089	320 190 090 090	320 190 090 100	320 190 090 119	320 190 090 120
Kalınlık	0,89 mm	0,90 mm	1,00 mm	1,19 mm	1,20 mm

B Braun Aesculap®
Uyumlu Modeller;
GA673,
GA668,
GB660R

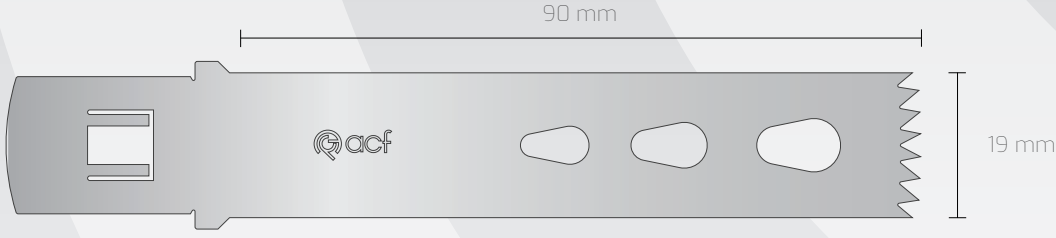

● Non Steril
● Steril R

Ref	320 190 090 127	320 190 090 130	320 190 090 137	320 190 090 140	320 190 090 147
Kalınlık	1,27 mm	1,30 mm	1,37 mm	1,40 mm	1,47 mm

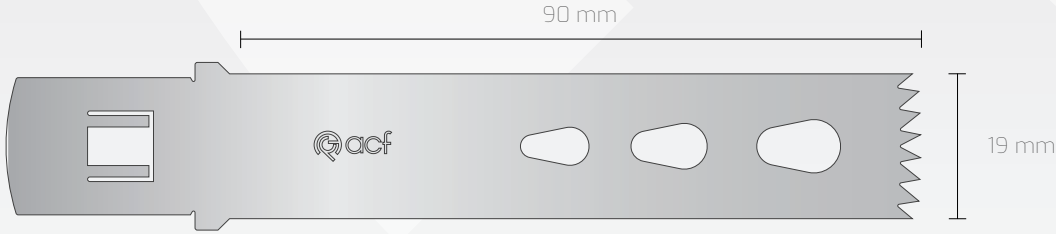

● Non Steril
● Steril R

Ref	320 190 090 150
Kalınlık	1,50 mm

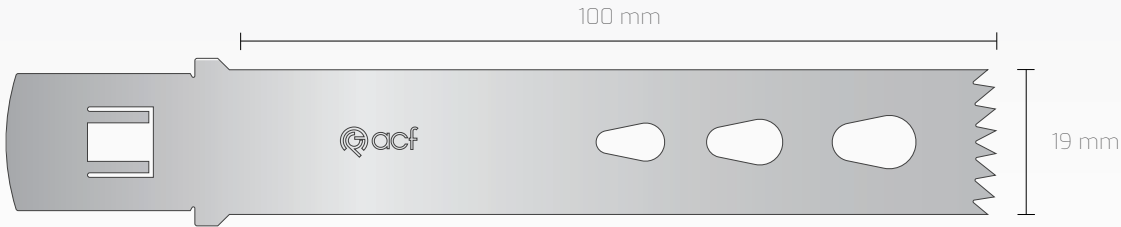

● Non Steril
● Steril R

Ref	320 190 100 089	320 190 100 090	320 190 100 100	320 190 100 119	320 190 100 120
Kalınlık	0,89 mm	0,90 mm	1,00 mm	1,19 mm	1,20 mm

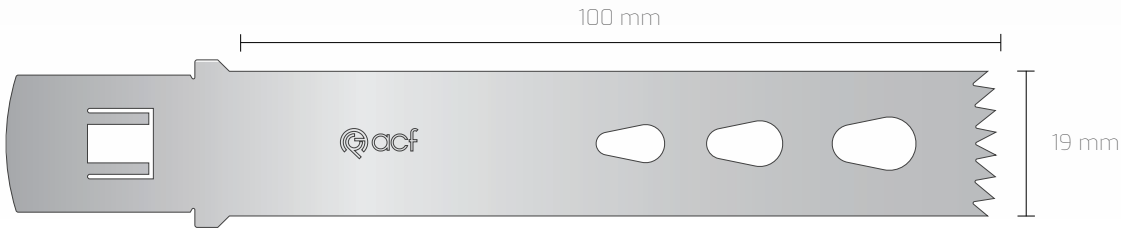

● Non Steril
● Steril R

Ref	320 190 100 127	320 190 100 130	320 190 100 137	320 190 100 140	320 190 100 147
Kalınlık	1,27 mm	1,30 mm	1,37 mm	1,40 mm	1,47 mm

Tüm testere bıçaklar gerçek ölçülerinde gösterilmiştir. 1:1

B BRAUN AESCULAP®

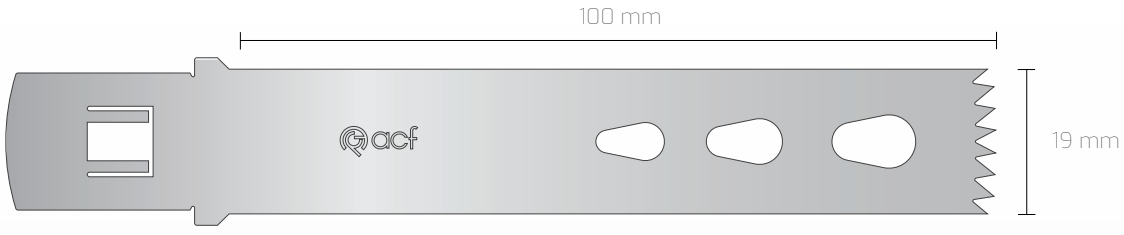

● Non Steril

● Steril R

Ref 320 190 100 150

Kalınlık 1,50 mm

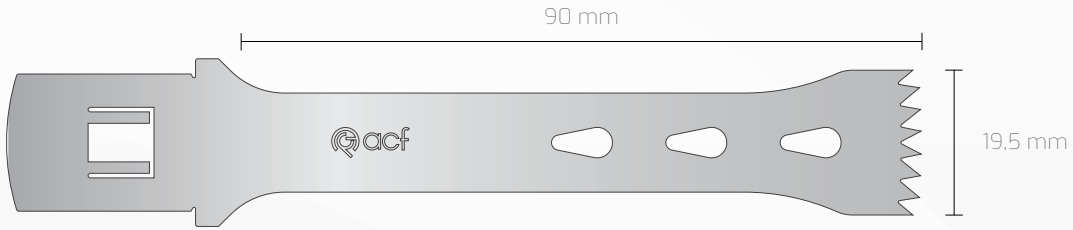

● Non Steril

● Steril R

Ref 320 195 090 089

Kalınlık 0,89 mm

Ref 320 195 090 090

Kalınlık 0,90 mm

Ref 320 195 090 100

Kalınlık 1,00 mm

Ref 320 195 090 119

Kalınlık 1,19 mm

Ref 320 195 090 120

Kalınlık 1,20 mm

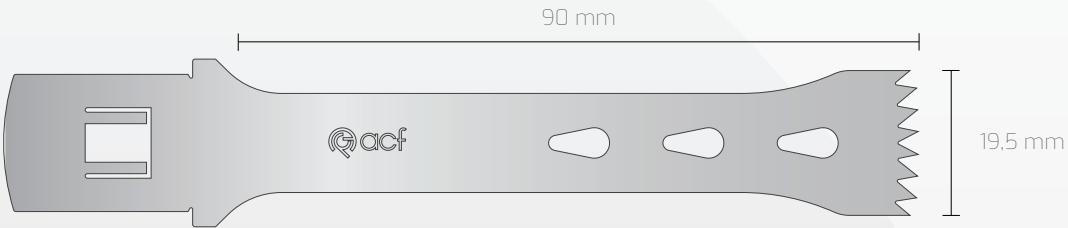

● Non Steril

● Steril R

Ref 320 195 090 127

Kalınlık 1,27 mm

Ref 320 195 090 130

Kalınlık 1,30 mm

Ref 320 195 090 137

Kalınlık 1,37 mm

Ref 320 195 090 140

Kalınlık 1,40 mm

Ref 320 195 090 147

Kalınlık 1,47 mm

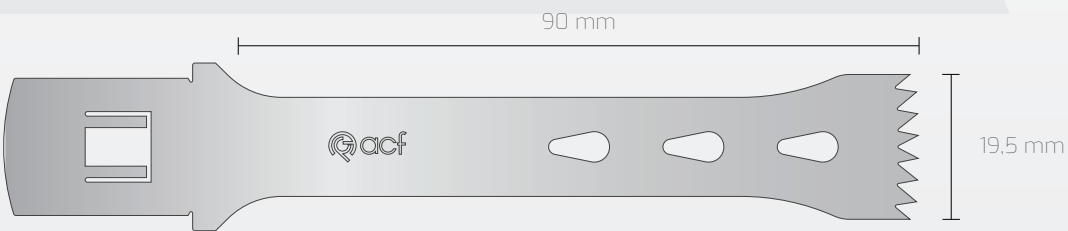

● Non Steril

● Steril R

Ref 320 195 090 150

Kalınlık 1,50 mm

B Braun Aesculap®
Uyumlu Modeller;
GA673,
GA668,
GB660R

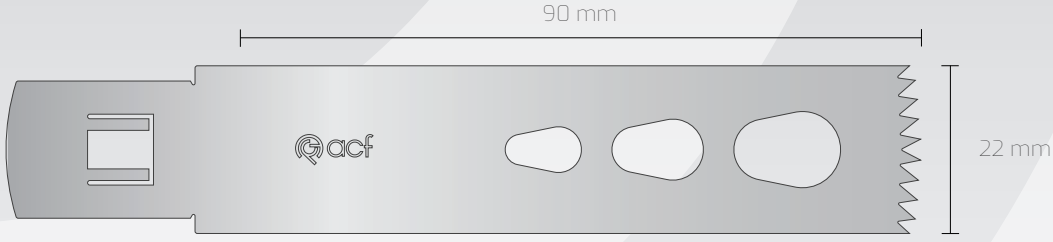

● Non Steril
● Steril R

Ref	320 220 090 089	320 220 090 090	320 220 090 100	320 220 090 119	320 220 090 120
Kalınlık	0,89 mm	0,90 mm	1,00 mm	1,19 mm	1,20 mm

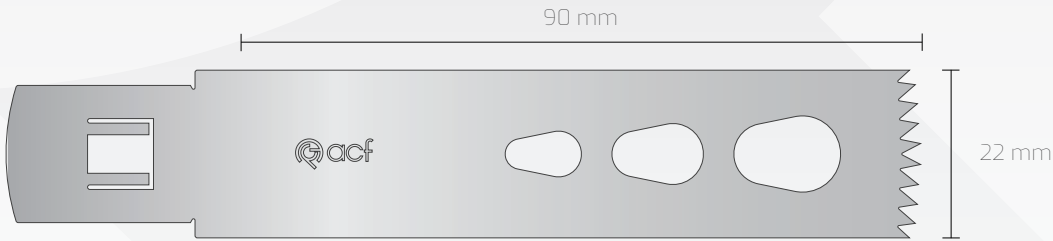

● Non Steril
● Steril R

Ref	320 220 090 127	320 220 090 130	320 220 090 137	320 220 090 140	320 220 090 147
Kalınlık	1,27 mm	1,30 mm	1,37 mm	1,40 mm	1,47 mm

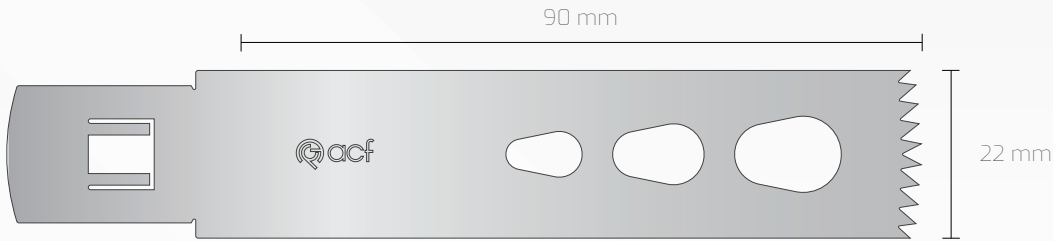

● Non Steril
● Steril R

Ref	320 220 090 150
Kalınlık	1,50 mm

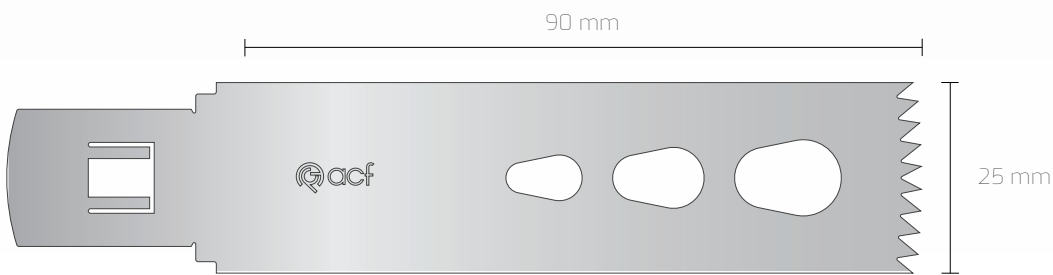

● Non Steril
● Steril R

Ref	320 250 090 089	320 250 090 090	320 250 090 100	320 250 090 119	320 250 090 120
Kalınlık	0,89 mm	0,90 mm	1,00 mm	1,19 mm	1,20 mm

Tüm testere bıçaklar gerçek ölçülerinde gösterilmiştir. 1:1

B BRAUN AESCULAP®

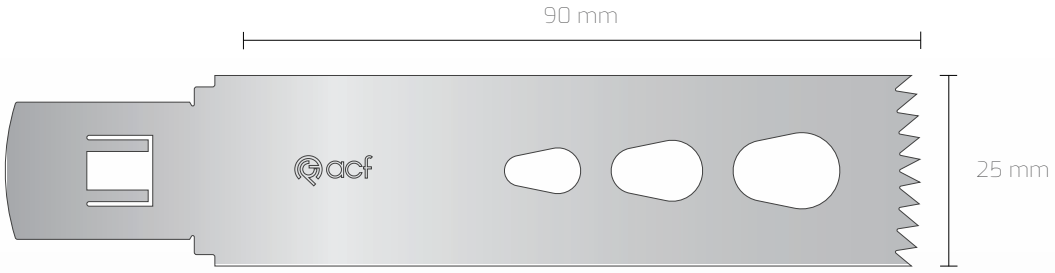

● Non Steril
● Steril R

Ref	320 250 090 127	320 250 090 130	320 250 090 137	320 250 090 140	320 250 090 147
Kalınlık	1,27 mm	1,30 mm	1,37 mm	1,40 mm	1,47 mm

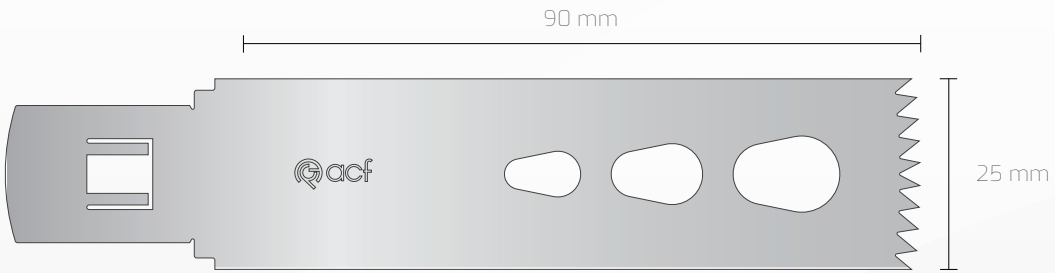

● Non Steril
● Steril R

Ref	320 250 090 150
Kalınlık	1,50 mm

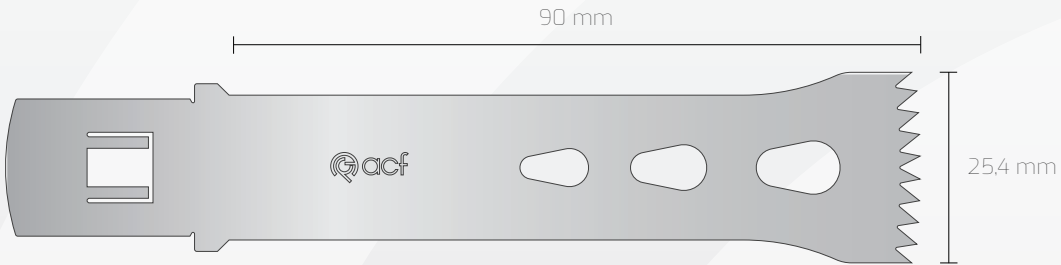

● Non Steril
● Steril R

Ref	320 254 090 089	320 254 090 090	320 254 090 100	320 254 090 119	320 254 090 120
Kalınlık	0,89 mm	0,90 mm	1,00 mm	1,19 mm	1,20 mm

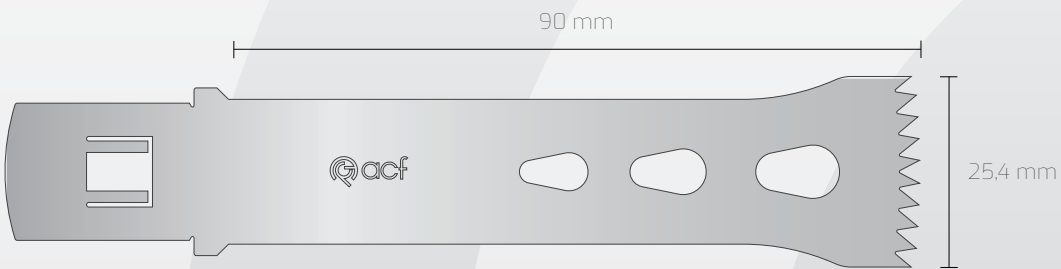

● Non Steril
● Steril R

Ref	320 254 090 127	320 254 090 130	320 254 090 137	320 254 090 140	320 254 090 147
Kalınlık	1,27 mm	1,30 mm	1,37 mm	1,40 mm	1,47 mm

B Braun Aesculap®

Uyumlu Modeller;

GA673,

GA668,

GB660R

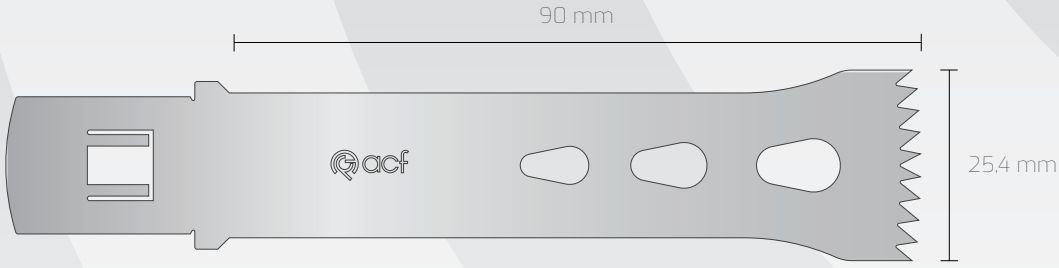

Non Steril

Steril R

Ref 320 254 090 150

Kalınlık 1,50 mm



Non Steril

Steril R

Ref 320 055 025 060

Kalınlık 0,60 mm



Non Steril

Steril R

Ref 320 090 025 060

Kalınlık 0,60 mm



Non Steril

Steril R

Ref 320 100 035 060

Kalınlık 0,60 mm

B BRAUN AESCULAP®

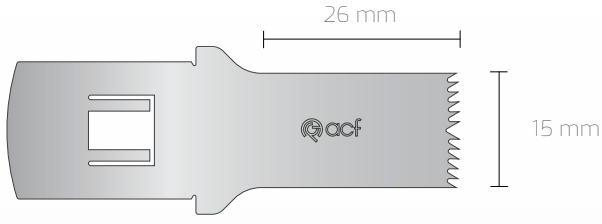
**Ref** 320 150 026 060

Kalınlık 0,60 mm

● Non Steril
● Steril R

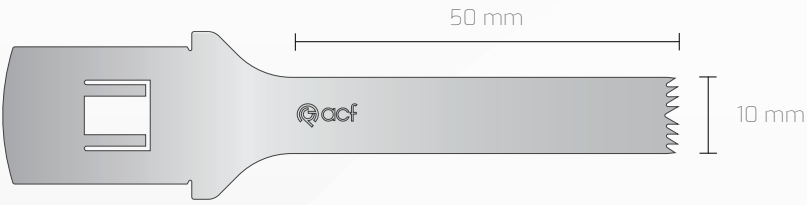
**Ref** 320 100 050 090

Kalınlık 0,90 mm

● Non Steril
● Steril R

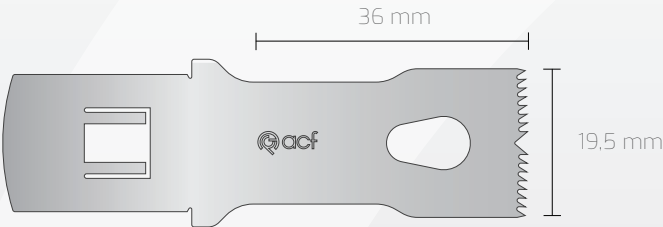
**Ref** 320 195 036 090

Kalınlık 0,90 mm

● Non Steril
● Steril R

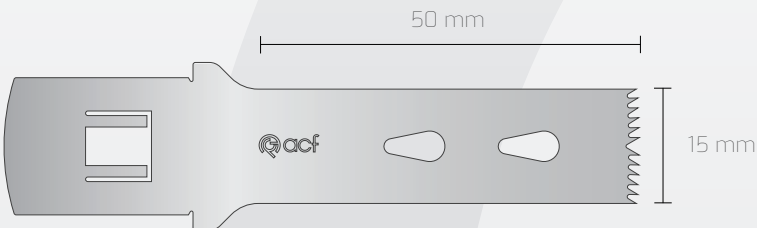
**Ref** 320 150 050 090

Kalınlık 0,90 mm

● Non Steril
● Steril R

B Braun Aesculap®

Uyumlu Modeller;

GA673,

GA668,

GB660R

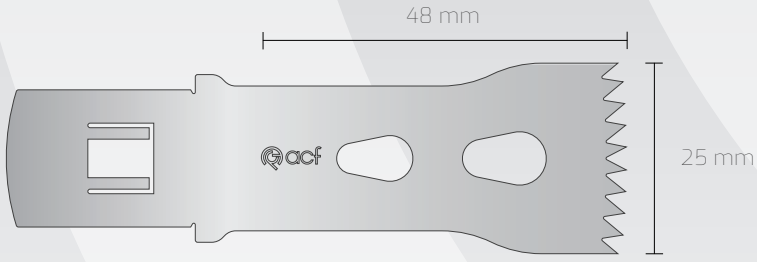

● Non Steril
● Steril R

Ref 320 250 048 090

Kalınlık 0,90 mm



● Non Steril
● Steril R

Ref 320 300 048 090

Kalınlık 0,90 mm

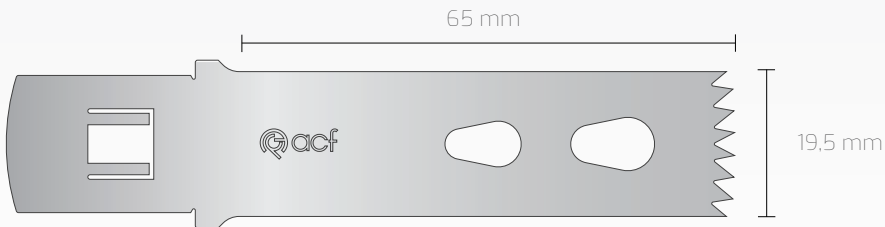

● Non Steril
● Steril R

Ref 320 195 065 090

Kalınlık 0,90 mm

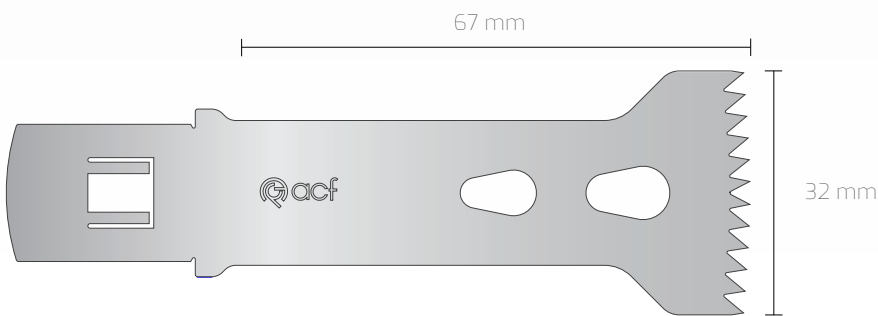

● Non Steril
● Steril R

Ref 320 320 067 090

Kalınlık 0,90 mm

B BRAUN AESCULAP®

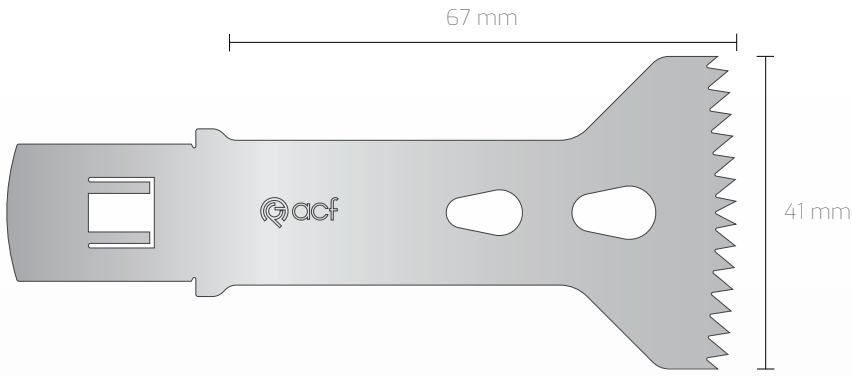

● Non Steril

● Steril R

Ref **320 410 067 090**

Kalınlık 0,90 mm

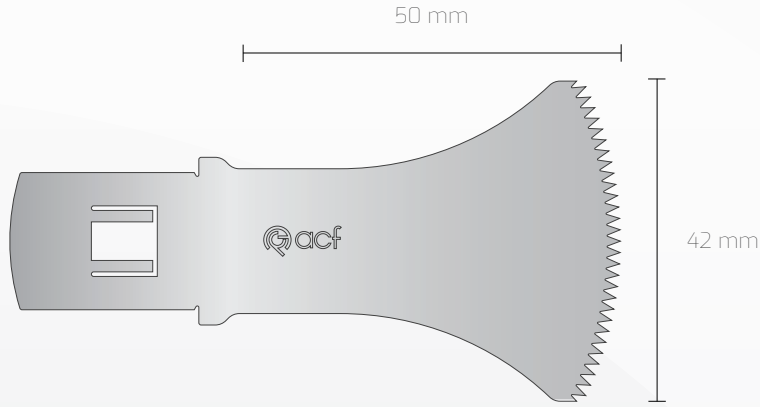

● Non Steril

● Steril R

Ref **320 420 050 090**

Kalınlık 0,90 mm

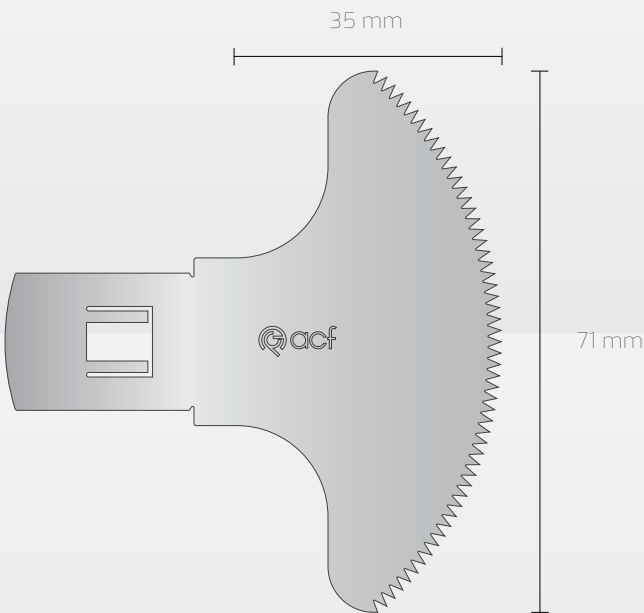

● Non Steril

● Steril R

Ref **320 710 035 090**

Kalınlık 0,90 mm

B Braun Aesculap®

Uyumlu Modeller;

GA673,

GA668,

GB660R

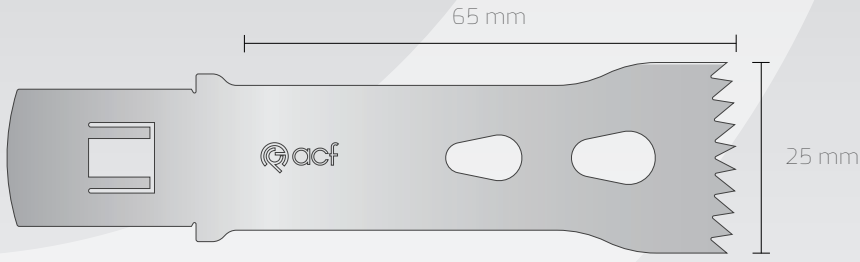

● Non Steril

● Steril R

Ref 320 250 065 090

Kalınlık 0,90 mm

B Braun Aesculap®

Uyumlu Modeller;

GB091R,

GB131R,

GA621

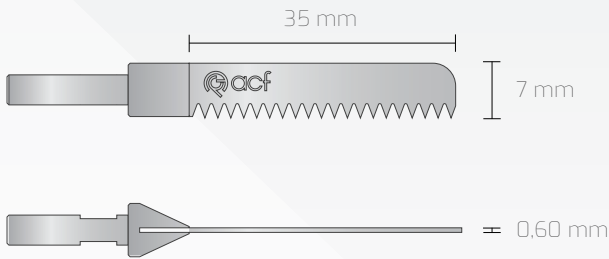

● Non Steril

● Steril R

Ref 320 070 035 060

Kalınlık 0,60 mm

B Braun Aesculap®

Uyumlu Modeller;

ELAN 4

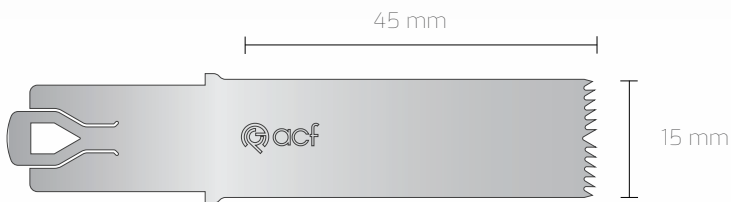

● Non Steril

● Steril R

Ref 320 150 045 060

Kalınlık 0,60 mm

B BRAUN AESCULAP®

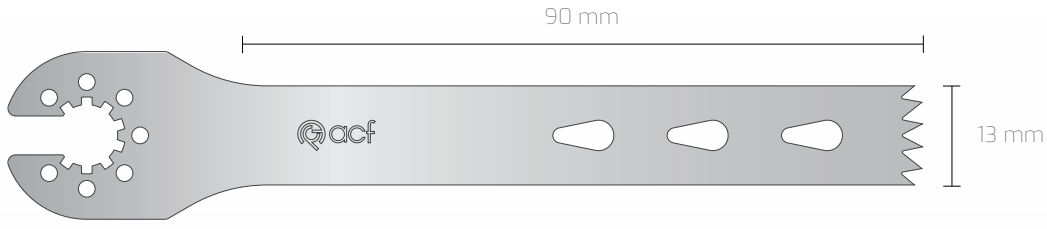

● Non Steril
● Steril R

Ref	330 130 090 089	330 130 090 090	330 130 090 100	330 130 090 119	330 130 090 120
Kalınlık	0,89 mm	0,90 mm	1,00 mm	1,19 mm	1,20 mm

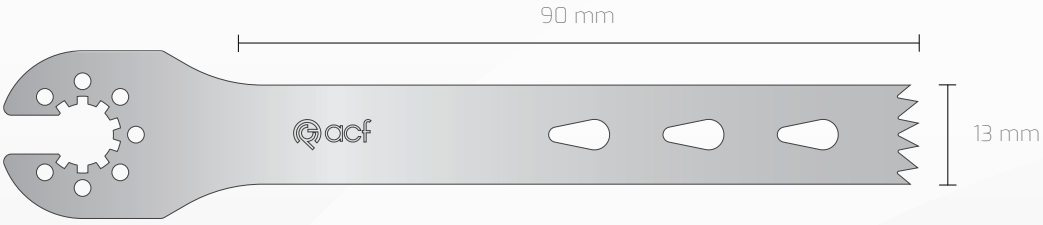

● Non Steril
● Steril R

Ref	330 130 090 127	330 130 090 130	330 130 090 137	330 130 090 140	330 130 090 147
Kalınlık	1,27 mm	1,30 mm	1,37 mm	1,40 mm	1,47 mm

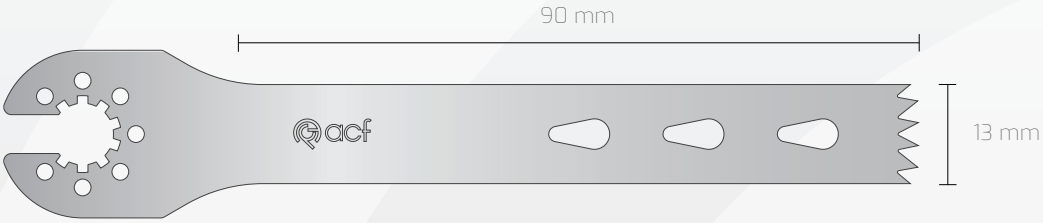

● Non Steril
● Steril R

Ref	330 130 090 150
Kalınlık	1,50 mm

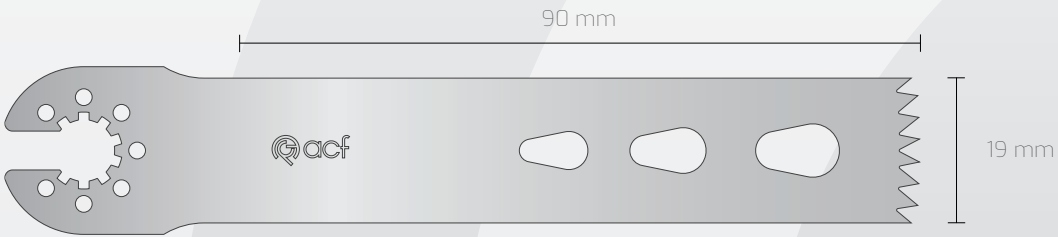

● Non Steril
● Steril R

Ref	330 190 090 089	330 190 090 090	330 190 090 100	330 190 090 119	330 190 090 120
Kalınlık	0,89 mm	0,90 mm	1,00 mm	1,19 mm	1,20 mm

B Braun Aesculap®

Uyumlu Modeller;
Acculan/Comfort, GA4040,
GA523, GA623, GA633, GA640,
GB125R, GB129, GB431, GB432

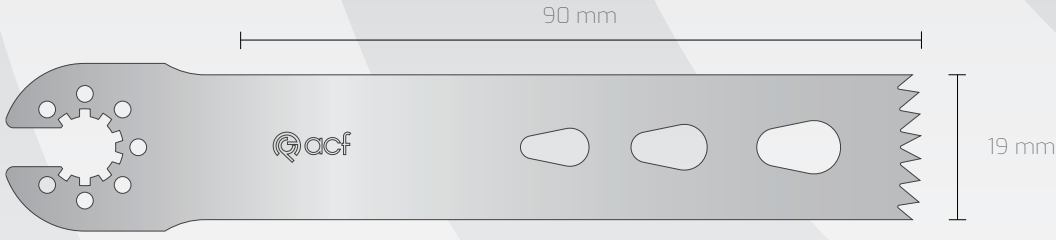

● Non Steril
● Steril R

Ref	330 190 090 127	330 190 090 130	330 190 090 137	330 190 090 140	330 190 090 147
Kalınlık	1,27 mm	1,30 mm	1,37 mm	1,40 mm	1,47 mm

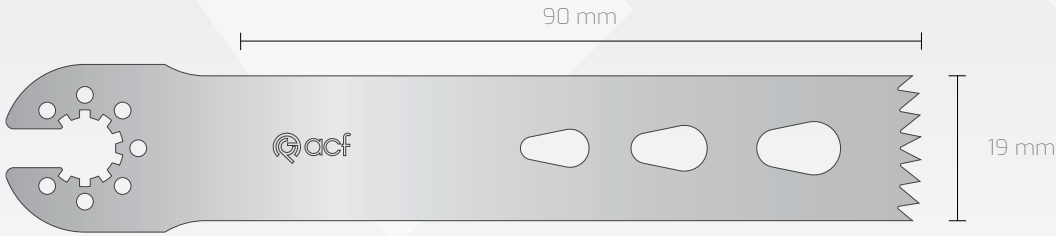

● Non Steril
● Steril R

Ref	330 190 090 150
Kalınlık	1,50 mm

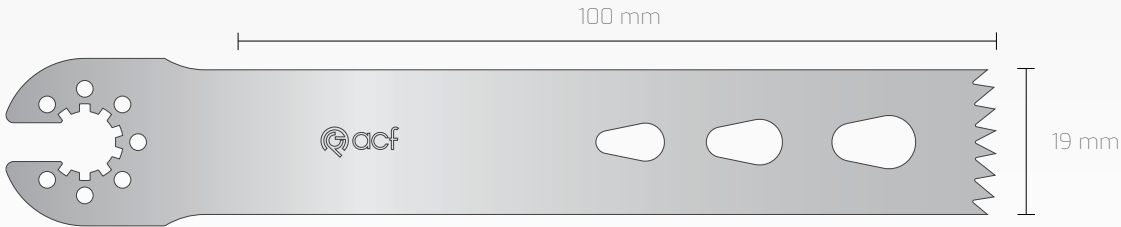

● Non Steril
● Steril R

Ref	330 190 100 089	330 190 100 090	330 190 100 100	330 190 100 119	330 190 100 120
Kalınlık	0,89 mm	0,90 mm	1,00 mm	1,19 mm	1,20 mm

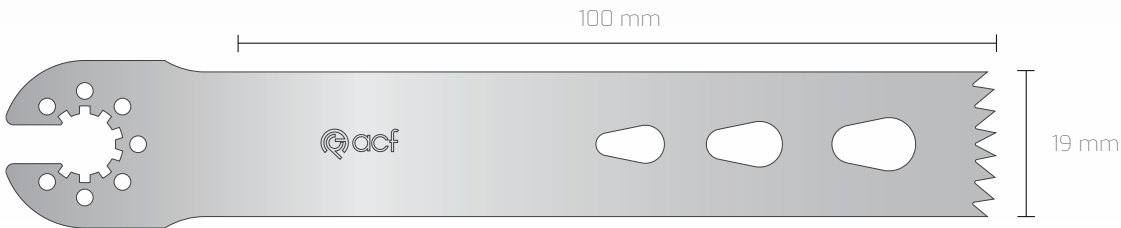

● Non Steril
● Steril R

Ref	330 190 100 127	330 190 100 130	330 190 100 137	330 190 100 140	330 190 100 147
Kalınlık	1,27 mm	1,30 mm	1,37 mm	1,40 mm	1,47 mm

Tüm testere bıçaklar gerçek ölçülerinde gösterilmiştir. 1:1

B BRAUN AESCULAP®

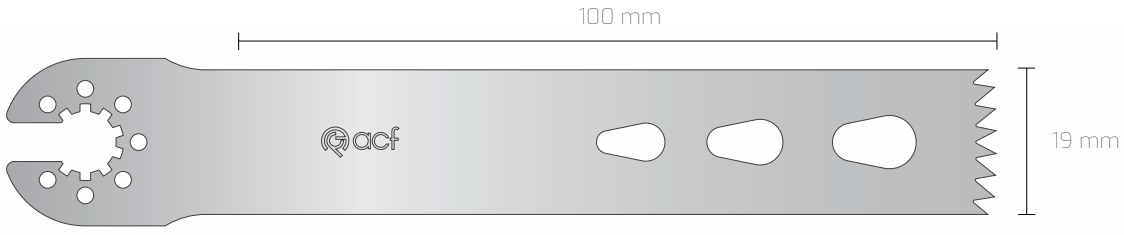

● Non Steril
● Steril R

Ref 330 190 100 150
Kalınlık 1,50 mm

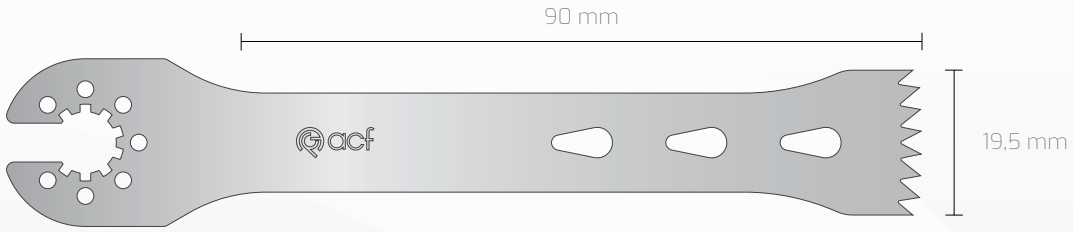

● Non Steril
● Steril R

Ref	330 195 090 089	330 195 090 090	330 195 090 100	330 195 090 119	330 195 090 120
Kalınlık	0,89 mm	0,90 mm	1,00 mm	1,19 mm	1,20 mm

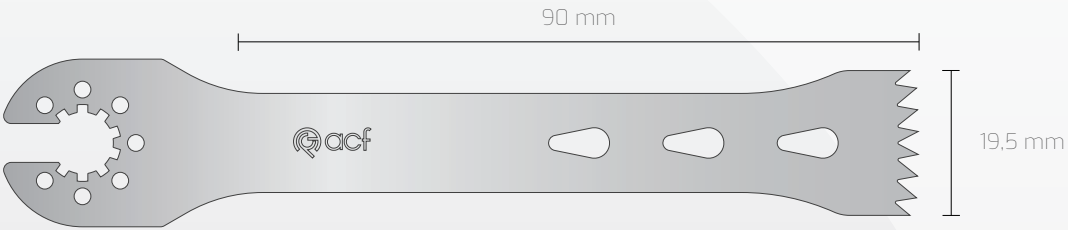

● Non Steril
● Steril R

Ref	330 195 090 127	330 195 090 130	330 195 090 137	330 195 090 140	330 195 090 147
Kalınlık	1,27 mm	1,30 mm	1,37 mm	1,40 mm	1,47 mm

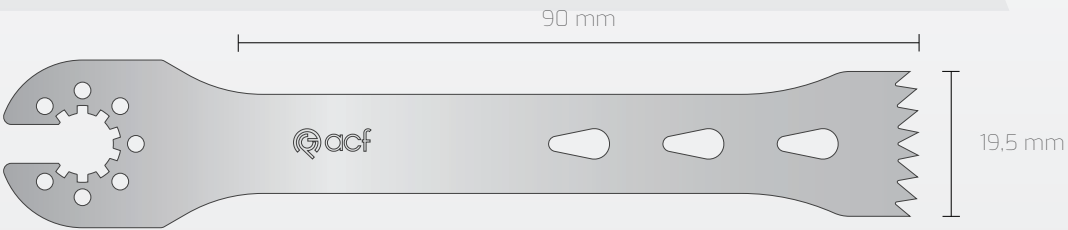

● Non Steril
● Steril R

Ref 330 195 090 150
Kalınlık 1,50 mm

B Braun Aesculap®

Uyumlu Modeller;

Acculan/Comfort, GA4040,
GA523, GA623, GA633, GA640,
GB125R, GB129, GB431, GB432

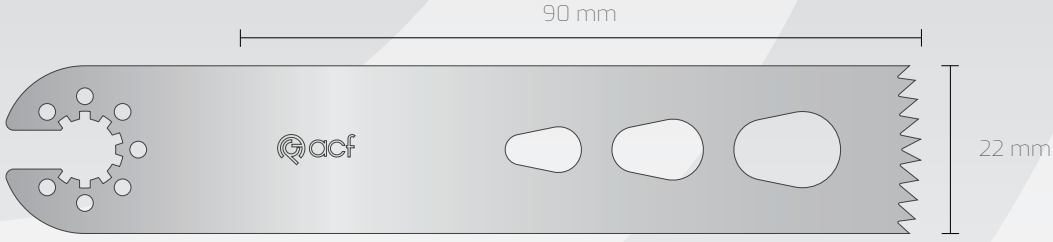

● Non Steril
● Steril R

Ref	330 220 090 089	330 220 090 090	330 220 090 100	330 220 090 119	330 220 090 120
Kalınlık	0,89 mm	0,90 mm	1,00 mm	1,19 mm	1,20 mm

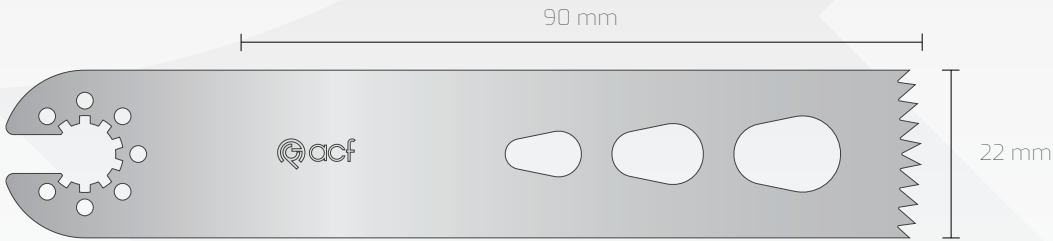

● Non Steril
● Steril R

Ref	330 220 090 127	330 220 090 130	330 220 090 137	330 220 090 140	330 220 090 147
Kalınlık	1,27 mm	1,30 mm	1,37 mm	1,40 mm	1,47 mm

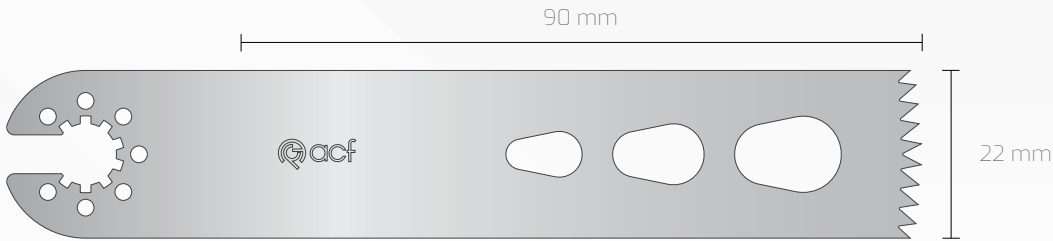

● Non Steril
● Steril R

Ref	330 220 090 150
Kalınlık	1,50 mm

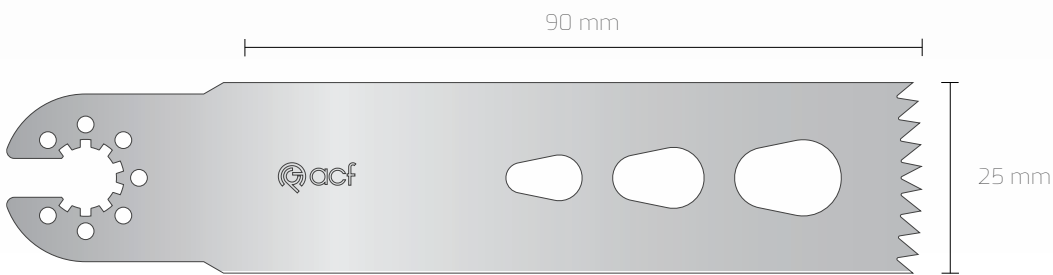

● Non Steril
● Steril R

Ref	330 250 090 089	330 250 090 090	330 250 090 100	330 250 090 119	330 250 090 120
Kalınlık	0,89 mm	0,90 mm	1,00 mm	1,19 mm	1,20 mm

Tüm testere bıçaklar gerçek ölçülerinde gösterilmiştir. 1:1

B BRAUN AESCULAP®

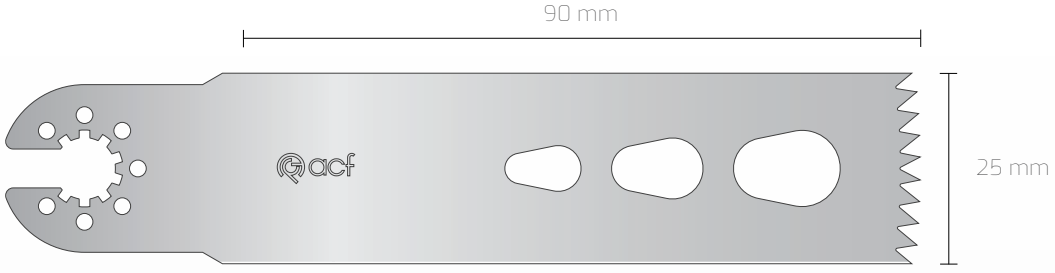

● Non Steril
● Steril R

Ref	330 250 090 127	330 250 090 130	330 250 090 137	330 250 090 140	330 250 090 147
Kalınlık	1,27 mm	1,30 mm	1,37 mm	1,40 mm	1,47 mm

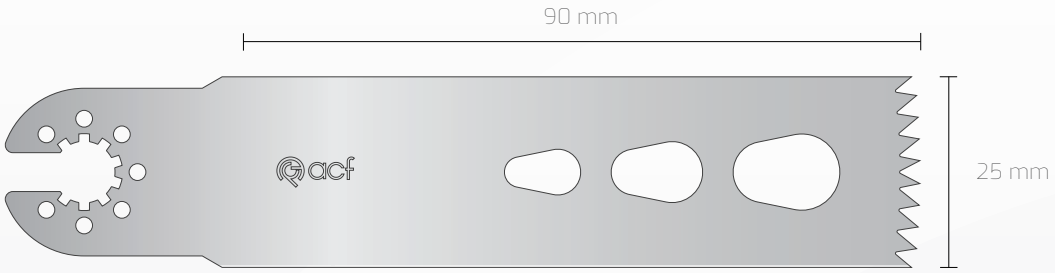

● Non Steril
● Steril R

Ref	330 250 090 150
Kalınlık	1,50 mm

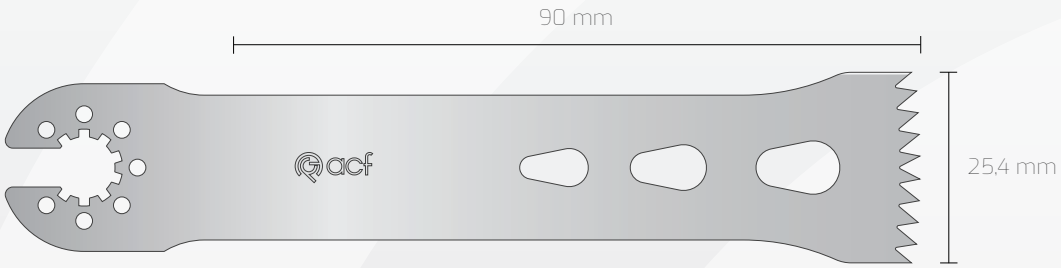

● Non Steril
● Steril R

Ref	330 254 090 089	330 254 090 090	330 254 090 100	330 254 090 119	330 254 090 120
Kalınlık	0,89 mm	0,90 mm	1,00 mm	1,19 mm	1,20 mm

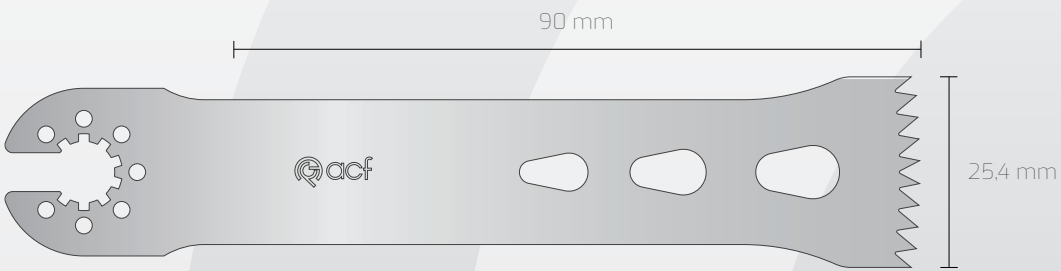

● Non Steril
● Steril R

Ref	330 254 090 127	330 254 090 130	330 254 090 137	330 254 090 140	330 254 090 147
Kalınlık	1,27 mm	1,30 mm	1,37 mm	1,40 mm	1,47 mm

B Braun Aesculap®

Uyumlu Modeller;

Acculan/Comfort, GA4040,
GA523, GA623, GA633, GA640,
GB125R, GB129, GB431, GB432

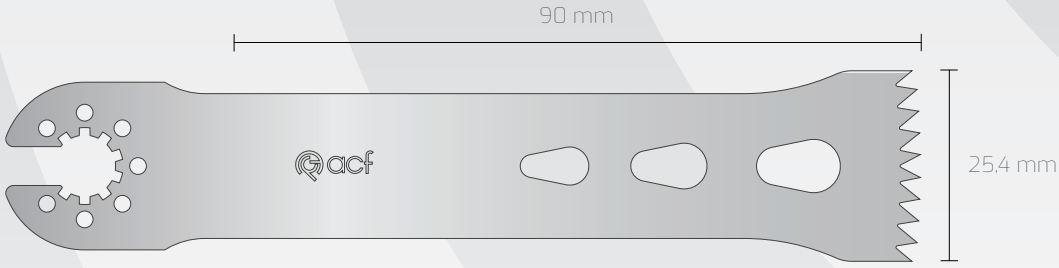

Non Steril

Steril R

Ref 330 254 090 150

Kalınlık 1,50 mm

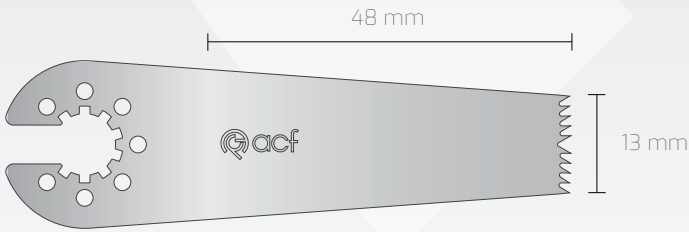

Non Steril

Steril R

Ref 330 130 048 060

Kalınlık 0,60 mm

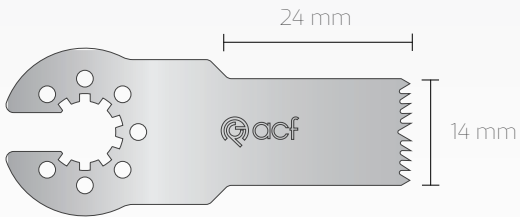

Non Steril

Steril R

Ref 330 140 024 060

Kalınlık 0,60 mm

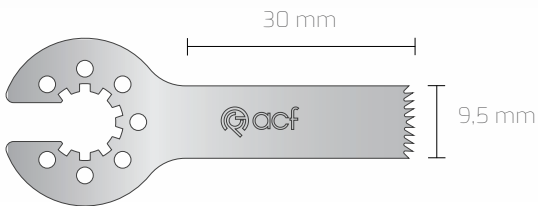

Non Steril

Steril R

Ref 330 095 030 060

Kalınlık 0,60 mm

B BRAUN AESCULAP®

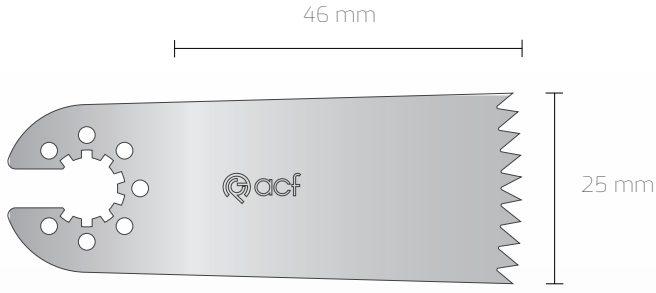

Ref 330 250 046 090
Kalınlık 0,90 mm

Non Steril
Steril R



Ref 330 220 046 090
Kalınlık 0,90 mm

Non Steril
Steril R

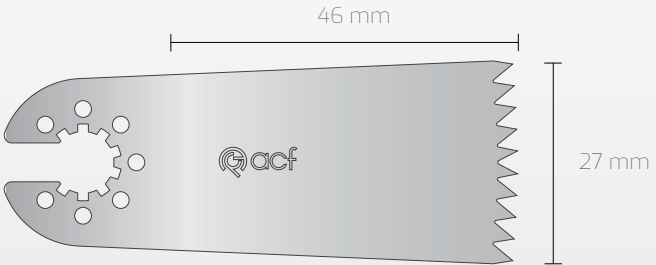

Ref 330 270 046 090
Kalınlık 0,90 mm

Non Steril
Steril R



Ref 330 130 043 060
Kalınlık 0,60 mm

Non Steril
Steril R

B Braun Aesculap®

Uyumlu Modeller;
Acculan/Comfort, GA4040,
GA523, GA623, GA633, GA640,
GB125R, GB129, GB431, GB432

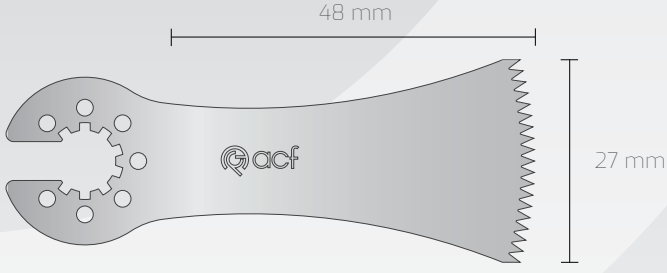

● Non Steril
● Steril R

Ref 330 270 048 090

Kalınlık 0,90 mm

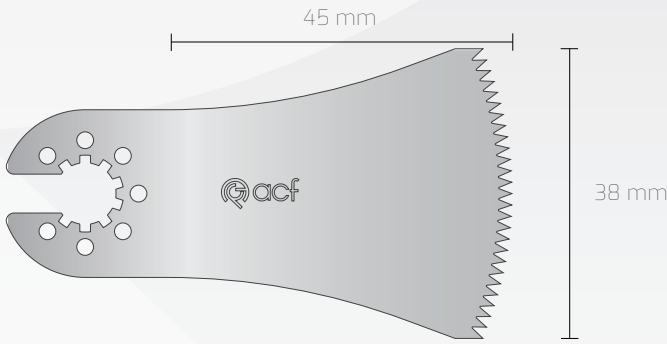

● Non Steril
● Steril R

Ref 330 380 045 090

Kalınlık 0,90 mm

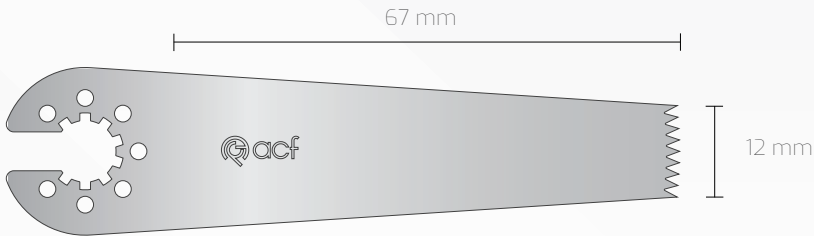

● Non Steril
● Steril R

Ref 330 120 067 090

Kalınlık 0,90 mm

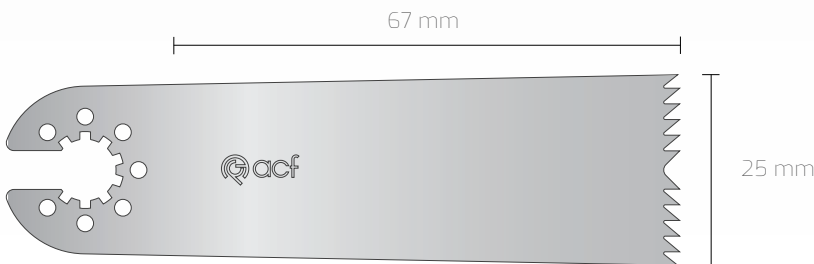

● Non Steril
● Steril R

Ref 330 250 067 090

Kalınlık 0,90 mm

B BRAUN AESCULAP®

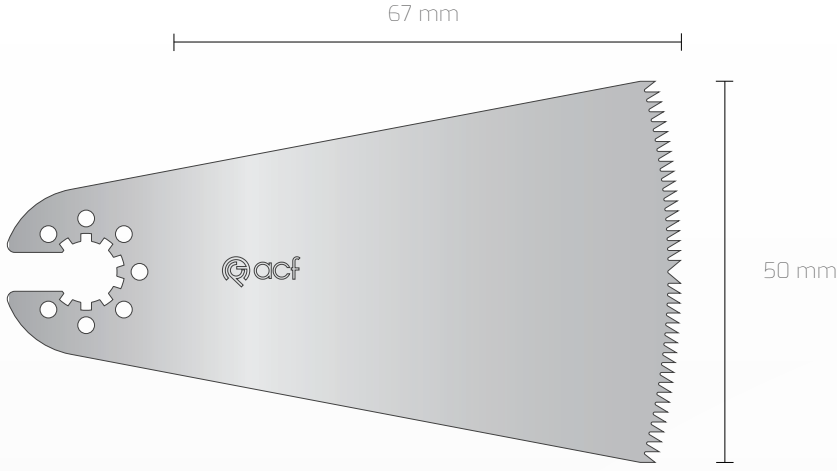

● Non Steril
● Steril R

Ref **330 500 067 060**
Kalınlık 0,60 mm



ACF Medikal Urunler Mak. San. ve Tic. Ltd. Sti.

Guzelyurt Mah. 5754 Sok. No: 3/A
Yunusemre / Manisa, Turkey, 45030

+90 236 236 28 20

info@acf.com.tr

www.acf.com.tr



ACF.MR.03.TR.R05 13.04.2021